

UniFit™

Unified Conical Connection



Table of Contents

Meet UniFit - Unified Connection	Page No.	TMA™ - Multi Unit	Page No.
About	4-7	Abutments Impression Transfers	
Implants	8	Scan Bodies Drivers	20-21
Drilling Sequence	9		
Cover Screws & Healing Abutments	10		
Impression		Overdenture Restoration	
Open / Close Tray Transfers	11	Attachments Driver Ball Caps	22
Scan Bodies	11		
Analogs	11	Screws	
		Abutment TMA Transfers	23
Cement-Retained Abutments		Surgical Kits	
Abutments	12-13	Review	24-25
		Surgical Kit-Premium	26
Casting Abutments		Surgical Kit-Advanced	27
Abutments	14		
		Drills & Tools	
Single TMA™		Tri-Step \ Twist Step Drills Tools	28-30
Abutments Impression Transfers		Torque Drivers Handpiece Adapters	30-31
Scan Bodies Drivers	15-16	Hand Drivers Retrieval Tool	32
		Guided Surgery	
CAD CAM		Implant Drill GS Kit	34-35
Ti Base C-Type Ti Base Abutments	17-19	Tools Kits GS Kit	36-37
		Additional Products	38



Meet UniFit™:
Your Unified Connection

Introducing UniFit™, your Unified Connection to hassle-free implants.

With 30 years of implantology knowledge and experience, we have taken the best of our platforms and combined them into our new UniFit™ implant.

Surgical and restoration procedures can be complicated, which is why we are focused on making them simple. With UniFit, one prosthetic connection fits all.

This means that ALL prosthetics and attachments fit ALL size and diameter UniFit implants

This means:

- No need for spares
- No multiple sizes for handpieces
- No extra storage for all the extra prosthetics!

Our innovative implant design features a friction 7° conical connection with a six-position star shape index that allows for one unified prosthetic connection to fit all implant diameters. This simplifies surgical and restoration procedures, making the process faster and more efficient.

UniFit™ ensures a solid fixture of the abutment, enhancing the implant-abutment seal and minimizing micromovements. Our unique design also enables simple yet flexible implant and abutment alignment, allowing for self-guiding insertion and clear-cut tactile feedback.

The external geometry and surface of UniFit™ are designed for immediate function and loading, providing optimal stability in all bone types. Every feature of UniFit™ is designed to enhance the success of the procedure and deliver better results, ensuring a better experience for both doctors and patients.

In short, the concept behind UniFit™ is simple, but the results are immediate. Say goodbye to complicated dental implant procedures and hello to a hassle-free experience with UniFit™.

NOTE:

- All measurements are in mm.
- Illustrations are not to scale
- Not all products may have been licensed in accordance with Canadian law



Built-In Platform
Switching

Back
tapered collar

Minimally
invasive surgery

Micro Threads:
Engineered to enhance bone
regeneration, prevent bone
loss & increase bone implant
contact

OsseoFix™ surface

Bone - condensing property
Self - drilling

Rounded apex

Seven degree
unified connical connection
Six position star index

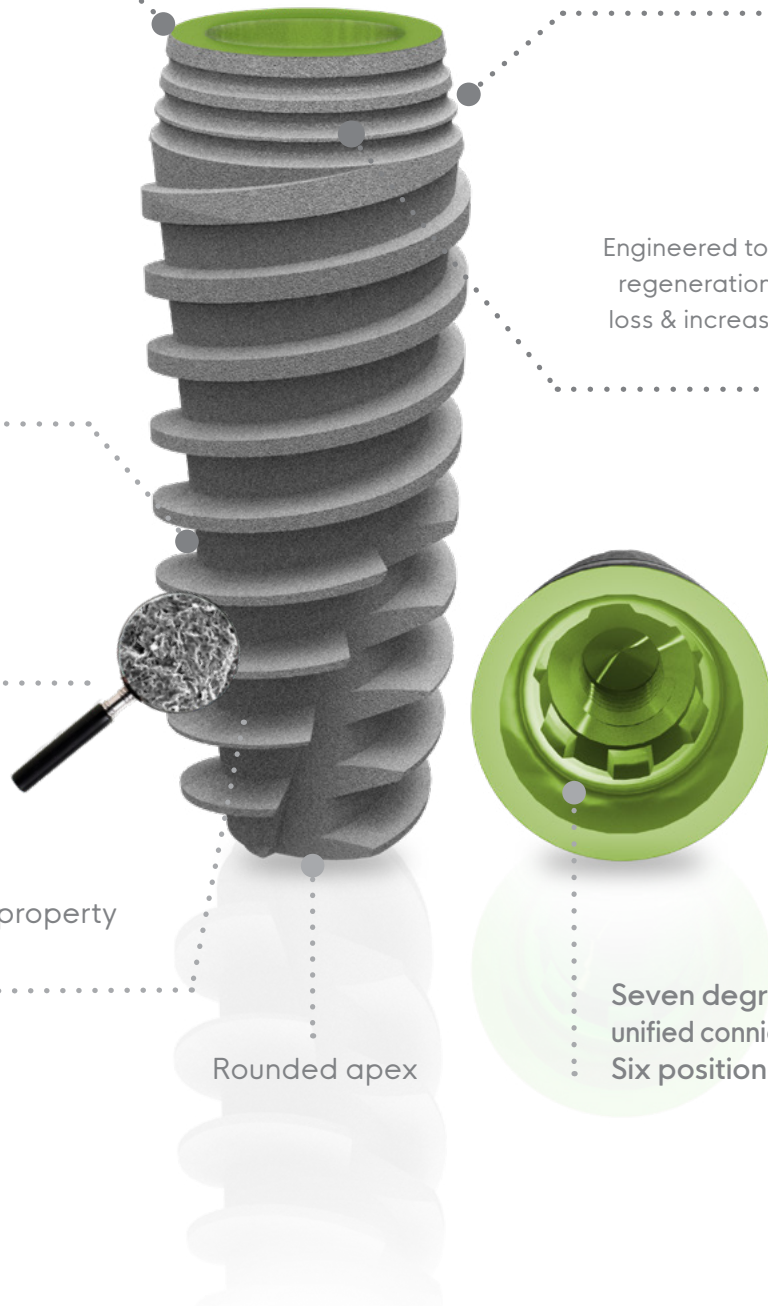

UniFit is a variable-thread tapered implant with a spiral tap that ensures immediate stability through bone condensation during implant placement.

- Variable threads and a tapered design allows for accurate implant placement, for self-tapping, and for improved aesthetics.
- Unique design also ensures better load distribution, allowing for immediate function on all bone types.

UniFit features Adin's OsseoFix™, a unique Calcium Phosphate blast surface treatment that enhances the implant's integration with the bone.

Experience immediate stability, improved accuracy, and better load distribution with UniFit Spiral Implant featuring Adin's OsseoFix™.

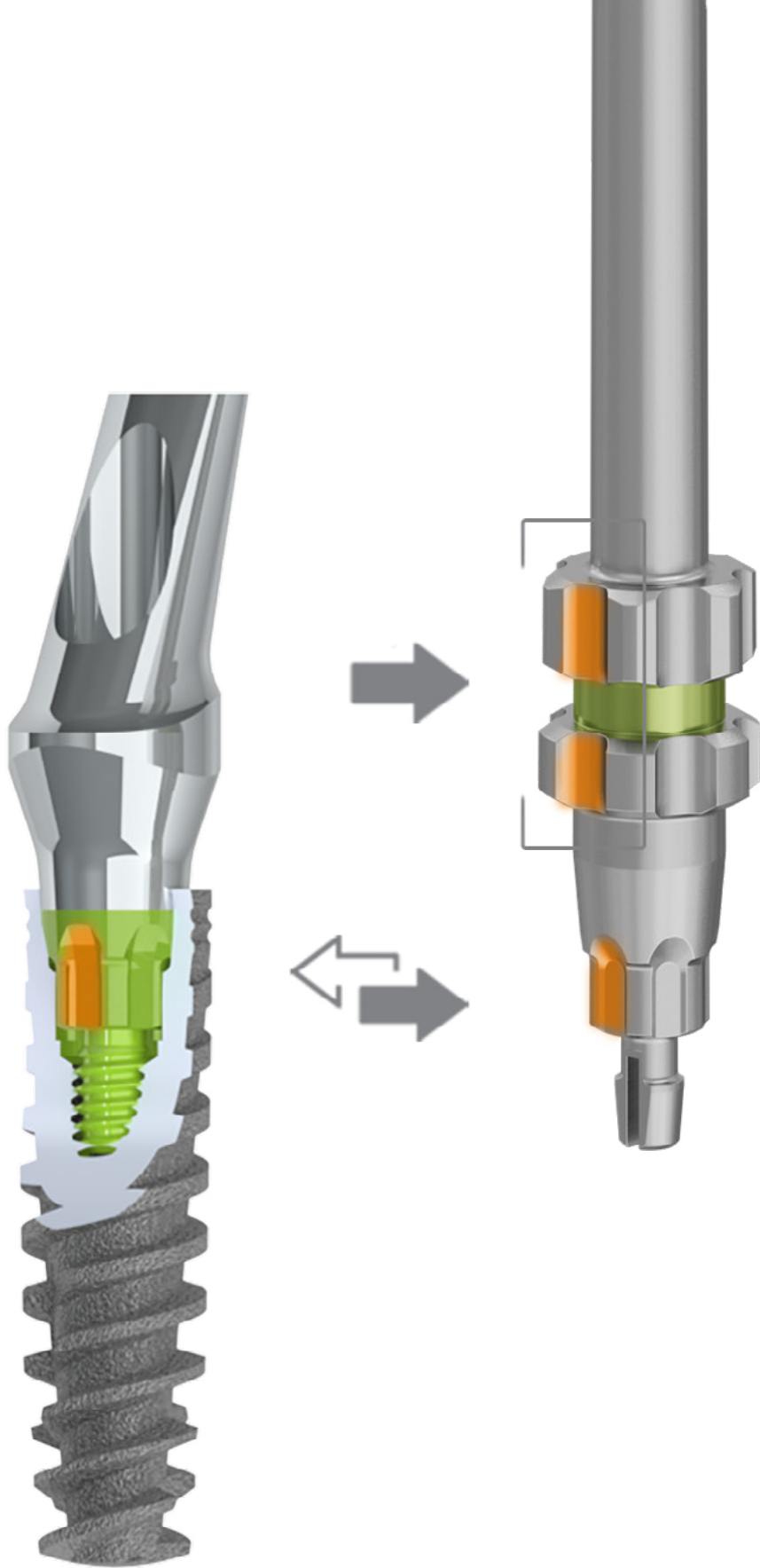

⚠ Implant - Abutment index alignment is indicated by implant driver grooves.

Implants

Recommended insertion torque up to 50 Ncm



	Ø	L	D1	D3	Catalog
	3.5	8.0	2.9	2.7	ISPUF0835
		10.0	2.9	2.6	ISPUF1035
		11.5	2.9	2.6	ISPUF1135
		13.0	2.9	2.6	ISPUF1335
		16.0	2.9	2.5	ISPUF1635
		18.0	2.9	2.5	ISPUF1835























	Ø	L	D1	D3	Catalog
	3.75	8.0	2.9	3.2	ISPUF0838
		10.0	2.9	3.1	ISPUF1038
		11.5	2.9	3.1	ISPUF1138
		13.0	2.9	3.1	ISPUF1338
		16.0	2.9	3.0	ISPUF1638
		18.0	2.9	3.0	ISPUF1838

	Ø	L	D1	D3	Catalog
	4.3	6.0	2.9	3.7	ISPUF0643
		8.0	2.9	3.4	ISPUF0843
		10.0	2.9	3.3	ISPUF1043
		11.5	2.9	3.2	ISPUF1143
		13.0	2.9	3.0	ISPUF1343
		16.0	2.9	2.8	ISPUF1643

	Ø	L	D1	D3	Catalog
	5.0	6.0	2.9	4.5	ISPUF0649
		8.0	2.9	4.1	ISPUF0849
		10.0	2.9	4.1	ISPUF1049
		11.5	2.9	4.0	ISPUF1149
		13.0	2.9	3.8	ISPUF1349

	Ø	L	D1	D3	Catalog
	6.0	6.0	2.9	5.5	ISPUF0660
		8.0	2.9	5.2	ISPUF0860
		10.0	2.9	5.2	ISPUF1060
		11.5	2.9	5.1	ISPUF1160

Drilling Sequence

Drilling speed** (rpm)	800-1200		800-1200		800-1200			800-1200		
Implant Diameter	Ø3.5/3.75		Ø4.3		Ø5.0			Ø6.0		
 <p>Hard Bone</p> <p>D1, D2</p>	 *Tri-step	 Ø3.5/3.75	 Ø3.6	 Ø4.3	 Ø4.2	 Ø4.6	 Ø5.0	 Ø5.2	 Ø5.6	 Ø6.0
 <p>Soft Bone</p> <p>D3, D4</p>	 *Tri-step	 Ø3.5/3.75	 Ø3.6	 Ø4.3	 Ø4.2	 Ø4.6	 Ø5.0	 Ø5.2	 Ø5.6	 Ø6.0



* For initial drilling, you may use Ø2, Ø2.8 and Ø3.2 drills in sequence instead of the Tri-step drill.

** Drilling should be performed at low speeds (800rpm-1200rpm) in accordance with bone quality at the specific site.

*For initial drilling, you may use a Tri-step drill instead of Ø2, Ø2.8 and Ø3.2 drills in sequence.

Note: (x.xx) Drill to the depth of the cortex only.

⚠ CAUTION: The drill preparation is up to 1mm longer than the implant. * The drill apical step is 1.8mmD.

Cover Screw & Healing Abutments

Recommended Torque 15(Ncm)

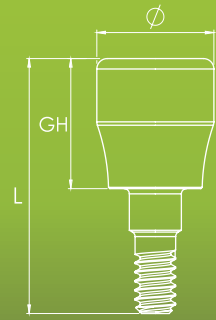

		L	Ø	Catalog
	Cover Screw	5.2	2.9	UF0073

		L	GH	Ø	Catalog
	UniFit Slim Conical Healing Abutment	6.8	2.0	3.5	UF0095
		7.8	3.0	3.5	UF0096
		8.8	4.0	3.5	UF0097
		9.8	5.0	3.5	UF0098
		10.8	6.0	3.5	UF0099

		L	GH	Ø	Catalog
	UniFit Regular Conical Healing Abutment	6.8	2.0	4.5	UF0090
		7.8	3.0	4.5	UF0091
		8.8	4.0	4.5	UF0092
		9.8	5.0	4.5	UF0093
		10.8	6.0	4.5	UF0094



		L	GH	Ø	Catalog
	UniFit Wide Conical Healing Abutment	6.8	2.0	5.5	UF0095W
		7.8	3.0	5.5	UF0096W
		8.8	4.0	5.5	UF0097W
		9.8	5.0	5.5	UF0098W
		10.8	6.0	5.5	UF0099W

Impression

Our components for taking impressions for all restoration types can be utilized for digital or conventional protocols, either implant-level, or abutment-level procedures.

Our broad range of solutions and flexible designs enable easy and accurate restorative planning, whether you're dealing with a single tooth, multiple teeth, bridge, or full mouth rehabilitation.

Transfers | Recommended Torque 15(Ncm)

		L	D1	Catalog
	UniFit Open Tray Transfer 4.4mmDx10mmL	14.7	5.0	UF5510
	UniFit Open Tray Transfer 4.4mmDx14mmL	18.7	5.0	UF5514
	UniFit Slim Open Tray Transfer 3.4mmDx10mmL	14.7	4.8	UF5610
	UniFit Slim Open Tray Transfer 3.4mmDx14mmL	18.7	4.8	UF5614

		L	D1	Catalog
	UniFit Slim Close Tray Transfer 3.4mmDx9mmL	11.7	3.4	UF5109
	UniFit Slim Close Tray Transfer 3.4mmDx13mmL	15.7	3.4	UF5113
	UniFit Close Tray Transfer 4.4mmDx9mmL	11.7	4.4	UF5209
	UniFit Close Tray Transfer 4.4mmDx13mmL	15.7	4.4	UF5213

Scan Bodies

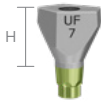
		H	Catalog
	UniFit Scan Body	7	UF0088

		H	Catalog
	UniFit Scan Body	10	UF0089

Digital Analogs

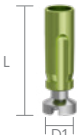
		L	D1	Catalog
	UniFit Digital Model Analog	10.0	3.55	UF0007

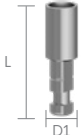
		L	D1	Catalog
	UniFit Implant Analog	12.6	3.6	UF0007





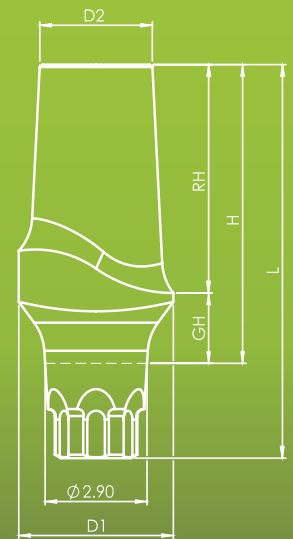

		Catalog
	Retaining Screw	RS1002

Cement Retained Abutments

Recommended Torque 35(Ncm)







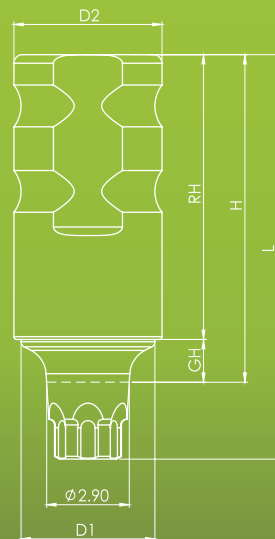

		L	D1	D2	H	GH	RH	Catalog
	UniFit Engaging Temporary Abutment Slim 3.5mmD	14.2	3.5	3.4	11.5	2	9.5	UF0036
	UniFit Non-Engaging Temporary Abutment Slim 3.5mmD	13.8	3.5	3.4	11.5	2	9.5	UF0037
	UniFit Engaging Temporary Abutment 4.5mmD	14.2	4.5	3.4	11.5	2	9.5	UF0043
	UniFit Non-Engaging Temporary Abutment 4.5mmD	13.8	4.5	3.4	11.5	2	9.5	UF0044
	UniFit Straight Abutment	12.2	4.4	3.2	9.5	3.0	6.5	UF0010
		11.2	4.4	3.2	8.5	2.0	6.5	UF0011
		10.2	4.4	3.2	7.5	1.0	6.5	UF0012
	UniFit Straight Abutment Wide	12.2	5.1	3.2	9.5	3.0	6.5	UF0010W
		11.2	5.1	3.2	8.5	2.0	6.5	UF0011W
		10.2	5.1	3.2	7.5	1.0	6.5	UF0012W

		L	D1	D2	H	GH	RH	Catalog
	UniFit Straight Slim Abutment No End Line	11.0	4.0	3.0	8.3	2.3	6.0	UF0020
	UniFit Angled Abutment 15°	10.2	4.4	2.3	7.5	1.0	6.5	UF0013
		11.2	4.4	2.3	8.5	2.0	6.5	UF0014
		12.2	4.4	2.3	9.5	3.0	6.5	UF0015
	UniFit Angled Abutment Wide 15°	10.2	5.1	2.3	7.5	1	6.5	UF0013W
		11.2	5.1	2.3	8.5	2	6.5	UF0014W
		12.2	5.1	2.3	9.5	3	6.5	UF0015W
	UniFit Angled Abutment 25°	10.7	4.4	2.9	8.0	1.5	6.5	UF2515
		12.2	4.4	2.9	9.5	3.0	6.5	UF2530
	UniFit Angled Abutment 35°	10.7	4.4	2.8	8.0	1.5	6.5	UF3515
		12.2	4.4	2.8	9.5	3.0	6.5	UF3530
	UniFit Angled Abutment Wide 25°	10.7	5.1	3.1	8	1.5	6.5	UF2515W
		12.2	5.1	3.1	9.5	3	6.5	UF2530W
	UniFit Angled Abutment Wide 35°	10.7	5.1	2.8	8	1.5	6.5	UF3515W
		12.2	5.1	2.8	9.5	3	6.5	UF3530W

Casting Abutments

Recommended Torque 35(Ncm)



		L	D1	D2	H	GH	RH	Catalog
	UniFit Plastic Cylinder Abutment Slim 3.5mmD	13.8	3.5	2.9	11.5	2	9.5	UF0038
	UniFit Plastic Cylinder Abutment 4.5mmD	13.8	4.5	4.5	11.5	2	9.5	UF0045
	UniFit Engaging Cobalt Chrome/Plastic Abutment	13.7	3.9	3.9	11	1	10	UF3094
	UniFit Non-Engaging Cobalt Chrome/Plastic Abutment	13.3	3.9	3.9	11	1	10	UF3100
	UniFit Engaging Cobalt Chrome/Plastic Abutment Wide	13.7	4.6	4.6	11	1	10	UF3094W
	UniFit Non-Engaging Cobalt Chrome/Plastic Abutment Wide	13.3	4.6	4.6	11	1	10	UF3100W

TMA™ Recommended

Torque 35(Ncm)

Adin's range of screw-retained restorations has expanded to include the single TMA. This option offers the benefits of TMA abutments while still allowing for accurate and flexible restoration of a single tooth.

With Adin's STMA, you can combine the advantages of a trans-gingival approach and a screw-retained single tooth restoration, resulting in increased flexibility in terms of aesthetics, safety, and maintenance.

The Single TMA also includes a hex index that provides the necessary accuracy for positioning and retention to support a single tooth crown. You can choose from open and closed tray transfers, and scan bodies for digital impressions, and replicas are available to streamline the work process.

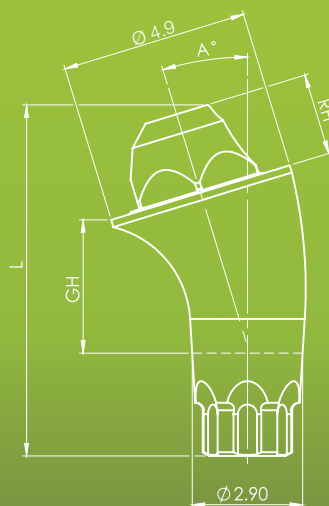

		L	H	GH	RH	Catalog
	UniFit Straight Single TMA 1mm	4.7	3.1	1.0	2.1	UF0032S
	UniFit Straight Single TMA 2mm	5.7	4.1	2.0	2.1	UF0033S
	UniFit Straight Single TMA 3mm	6.7	5.1	3.0	2.1	UF0034S
	UniFit Straight Single TMA 4mm	7.7	6.1	4.0	2.1	UF3729S
	UniFit Straight Single TMA 5mm	8.7	7.1	5.0	2.1	UF3730S
	UniFit Angled Single TMA 17° 2.5mm	8.2	5.6	2.5	2.2	UF3734S
	UniFit Angled Single TMA 30° 3mm	9.2	6.5	3.0	2.2	UF3735S
	UniFit Angled Single TMA 17° 3.5mm	9.3	6.5	3.5	2.2	UF3737S
	UniFit Angled Single TMA 30° 4mm	10.3	7.5	4.0	2.2	UF3738S

	L	D1	D2	Catalog
	11.0	4.9	3.1	RS5006S

	L	D1	D2	Catalog
	8.0	4.9	4.1	RS5011S

	L	D1	Catalog
	6.0	4.9	TM0006S

	L	D1	Catalog
	9.0	4.9	TM0009S

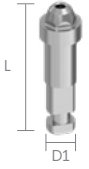
		L	D1	Catalog
	Single TMA Abutment Replica	16.8	3.35	RS5004S

		L	D1	D2	Catalog
	Single TMA Digital Model Replica Recommended torque 15(Ncm)	12.0	4.9	3.8	RS1001S

STMA Screw | For Scan Body & Cementing Cone

		Catalog
	TMA Scan Body Screw	TM0001

STMA Screw | Temporary Cylinder & STMA Direct Option

		Catalog
	TMA Prosthetic Screw	RS3404

STMA Prosthetics

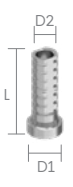
		L	D1	D2	H	Catalog
	Single TMA Titanium Temporary	12.0	4.9	3.5	10.5	RS4900S

		L	D1	D2	H	Catalog
	Single TMA Plastic Casting Sleeve w/Prosthetic Screw	12.0	4.9	3.3	10.5	RS5001S

		L	D1	D2	Catalog
	Single TMA Cementing Cone, low profile	4.9	5.5	3.2	TM0011S

Tool Drivers | For Angled TMA/TMA Prosthetic Screws

		L	Catalog
	Star Hand Driver Short	23.4	RP0064

		L	Catalog
	Star Hand Driver Long	28.4	RP0004

TMA™ - Multi Unit

Recommended Torque 35(Ncm)

Our TMA™ (Trans Mucosal Abutment) system is indicated for multiple-unit, screw-retained restorations, and may be used in combination with an implant-level framework design.

- Elevates restorative seating platform when implant-level restoration is not practical
- Provides better access when using implants with divergent angles
- Accommodates full and partial edentulous arches
- Available in straight or angled (17°, 30°, 45°) with different gingival heights
- Abutments are delivered with handles for easy insertion and seating

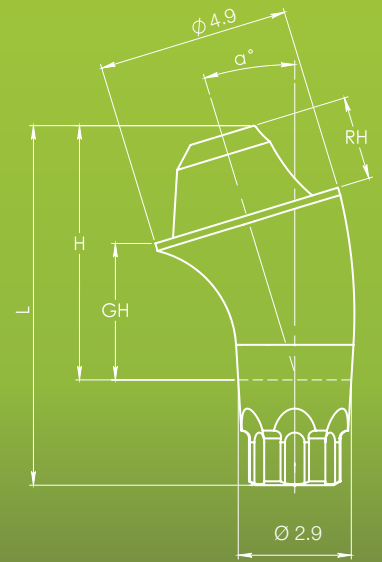

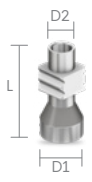
		L	D1	D2	Catalog
	TMA Impression Coping Open Tray	11.0	4.9	3.1	RS5006

		L	D1	D2	Catalog
	TMA Closed Tray Transfer	8.0	4.9	4.0	RS5011

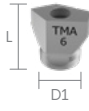
		L	D1	Catalog
	TMA Scan Body	6.0	4.9	TM0006

		L	D1	Catalog
	TMA Scan Body	9.0	4.9	TM0009

CAD CAM

Adin's CAD - CAM components and digital libraries enable clinicians and technicians to design and manufacture state-of-the-art restorations supported by Adin's implants, using current digital restoration processes.

The variety of components ensures endless restorative options for treatment of single, multiple, partially, or fully edentulous cases.

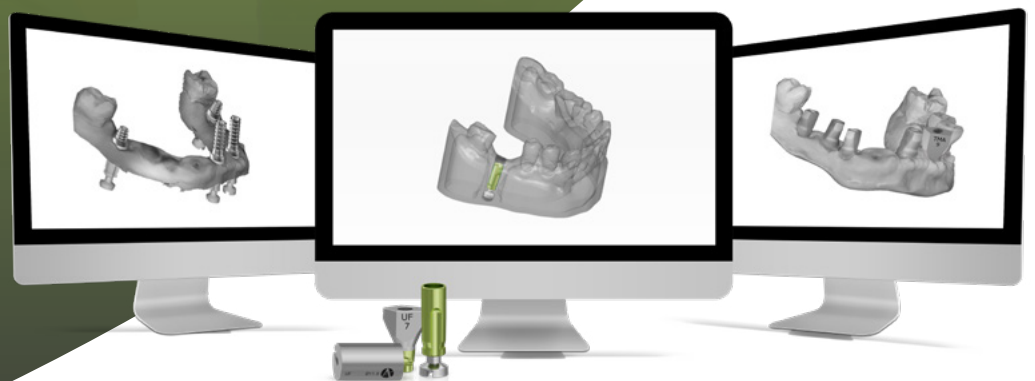

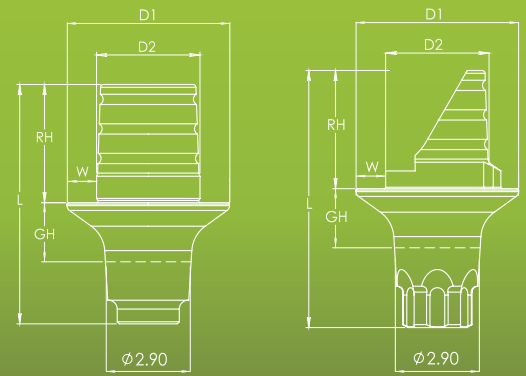

Ti Base Abutments

Recommended Torque 35(Ncm)



		L	RH	GH	D1	D2	W	Catalog
	Ti Base UniFit Abutment, Engaged	9.7	6	1	4.5	3.1	0.5	TB07611
		10.7	6	2	4.5	3.1	0.5	TB07621
		11.7	6	3	4.5	3.1	0.5	TB07631
		13.7	8	3	4.5	2.9	0.5	TB07831

		L	RH	GH	D1	D2	W	Catalog
	Ti Base UniFit Abutment, Engaged Wide	9.7	6	1	5.5	3.1	1	TB07611W
		10.7	6	2	5.5	3.1	1	TB07621W
		11.7	6	3	5.5	3.1	1	TB07631W
		13.7	8	3	5.5	3.1	1	TB07831W

		L	RH	GH	D1	D2	W	Catalog
	Ti Base UniFit Abutment, Non-Engaged	9.0	6	1	4.5	3.1	0.5	TB07612
		10.0	6	2	4.5	3.1	0.5	TB07622
		11.0	6	3	4.5	3.1	0.5	TB07632
		13.0	8	3	4.5	2.9	0.5	TB07832

		L	RH	GH	D1	D2	W	Catalog
	Ti Base UniFit Abutment, Non-Engaged Wide	9.0	6	1	5.5	3.1	1	TB07612W
		10.0	6	2	5.5	3.1	1	TB07622W
		11.0	6	3	5.5	3.1	1	TB07632W
		13.0	8	3	5.5	2.9	1	TB07832W

		L	RH	GH	D1	D2	W	Catalog
	Ti Base UniFit Abutment, Angular	7.7	4	1	4.5	3.2	0.5	TB07413
		8.7	4	2	4.5	3.2	0.5	TB07423
		9.7	4	3	4.5	3.2	0.5	TB07433

C-Type Ti Base Abutments

Recommended Torque 35(Ncm)

For further product information and use please refer to IFU028

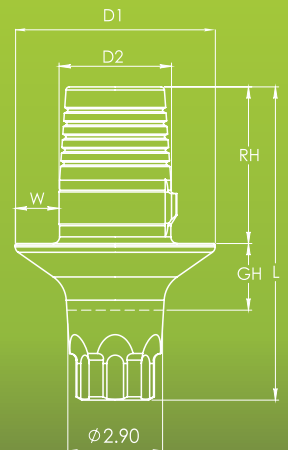

		L	RH	GH	D1	D2	W	Catalog
	C-Type Ti Base UniFit Abutment, Engaged	8.4	4.7	1	4.3	3.36	0.5	TB07414
		9.4	4.7	2	4.3	3.36	0.5	TB07424
		10.4	4.7	3	4.3	3.36	0.5	TB07434

		L	RH	GH	D1	D2	W	Catalog
	C-Type Ti Base UniFit Abutment, Engaged Wide	8.4	4.7	1	6	3.36	0.5	TB07414W
		9.4	4.7	2	6	3.36	0.5	TB07424W
		10.4	4.7	3	6	3.36	0.5	TB07434W

		L	RH	GH	D1	D2	W	Catalog
	C-Type Ti Base UniFit Abutment, Non-Engaged	8	4.7	1	4.3	3.36	1.3	TB07415
		9	4.7	2	4.3	3.36	1.3	TB07425
		10	4.7	3	4.3	3.36	1.3	TB07435

		L	RH	GH	D1	D2	W	Catalog
	C-Type Ti Base UniFit Abutment, Non-Engaged Wide	8	4.7	1	6	3.36	1.3	TB07415W
		9	4.7	2	6	3.36	1.3	TB07425W
		10	4.7	3	6	3.36	1.3	TB07435W

		L	D1	D2	Catalog
	TMA Healing Cup	5.5	4.9	3.5	RS5005

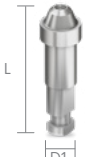
		L	D1	Catalog
	TMA Abutment Replica	16.8	3.35	RS5004

		L	D1	D2	Catalog
	TMA Digital Model Replica Recommended torque 15(Ncm)	12.0	4.9	3.8	RS1001

TMA Screw | For Scan Body & Cementing Cone

		Catalog
	TMA Scan Body Screw	TM0001

TMA Screw | Temporary Cylinder & TMA Direct Option

		Catalog
	TMA Prosthetic Screw	RS3404

TMA Prosthetics

		L	D1	D2	H	Catalog
	TMA Titanium Temporary	12.0	4.9	3.5	10.5	RS4900

		L	D1	D2	H	Catalog
	TMA Plastic Casting Sleeve w/Prosthetic Screw	12.0	4.9	3.3	10.5	RS5001

		L	D1	D2	Catalog
	TMA Cementing Cone, low profile	4.9	5.5	3.2	TM0011

Overdenture Restoration

Recommended Torque 35(Ncm)

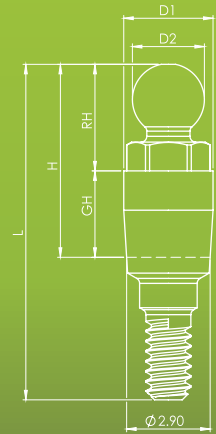

		L	D1	D2	H	GH	RH	Catalog
	UniFit Ball Attachment 0.5mm	9.1	3.1	2.5	4.1	0.6	3.5	UF0051
	UniFit Ball Attachment 1mm	9.5	3.1	2.5	4.5	1.0	3.5	UF0052
	UniFit Ball Attachment 2mm	10.5	3.1	2.5	5.5	2.0	3.5	UF0053
	UniFit Ball Attachment 3mm	11.5	3.1	2.5	6.5	3.0	3.5	UF0054
	UniFit Ball Attachment 4mm	12.5	3.1	2.5	7.5	4.0	3.5	UF0055
	UniFit Ball Attachment 5mm	13.5	3.1	2.5	8.5	5.0	3.5	UF0056

		L	Ø	Catalog
	Ball Attachment Replica	16.6	4.0	RS5740

		Catalog
	Torque Driver for Ball Attachment	RS6090

		L	Ø	D2	Catalog
	Plastic Ball Cap White (Nylon)	2.6	4.1	3.6	RS2660



		L	Ø	D2	Catalog
	Plastic Ball Cap Pink Soft (Nylon)	2.6	4.1	3.6	RS2662

		L	Ø	D2	Catalog
	Titanium Ball Cap	2.9	4.7	4.7	RS2670

Screws

Recommended Torque 35(Ncm)



		L	D1	Catalog
	UniFit Abutment Screw M1.6	7.2	2.2	UF0001
	UniFit Retaining Screw for Angled TMA	7.6	1.95	UF3403
	UniFit Retaining Screw for TMA 1mm	8	3.1	UF0039
	UniFit Retaining Screw for TMA 2mm	9	3.1	UF0040
	UniFit Retaining Screw for TMA 3mm	10	3.1	UF0041
	UniFit Retaining Screw for TMA 4mm	11	3.1	UF3409
	UniFit Retaining Screw for TMA 5mm	12	3.1	UF3412
	UniFit Open Tray Transfer Screw Short	24	3.1	UF5010
	UniFit Open Tray Transfer Screw Long	28	3.1	UF5014
	UniFit Close Tray Transfer Screw Short	16	2.8	UF5126
	UniFit Close Tray Transfer Screw Long	20	2.8	UF5127

Surgical Kits

































Successful surgical procedures start with having the right instruments and tools to ensure your desired treatment outcomes are met.

That's why our range has everything you need, including drills, keys, ratchets, and insertion tools.

Not only do they make procedures safer and easier, they result in an enhanced patient experience.

Our surgical kits streamline and simplify your implant procedures.



Drills			Premium Kit	Advanced Kit
	RS8032	Tip Drill	V	V
	TD2218	Three Step Drill-Long	V	V
	DL1820	Pilot Drill 2mmD x 8-18mmL	V	V
	DL1828	Twist Step Drill 2.3/2.8mmD x 8-18mmL	V	V
	DL1832	Twist Step Drill 2.8/3.2mmD x 8-18mmL	V	V
	DL1836	Twist Step Drill 3.2/3.6mmD x 8-18mmL	V	V
	DL1842	Twist Step Drill 3.6/4.2mmD x 8-18mmL	V	V
	DL1846	Twist Step Drill 4.2/4.6mmD x 8-18mmL	V	V
	DL1852	Twist Step Drill 4.6/5.2mmD x 8-18mmL	V	V
	DL1856	Twist Step Drill 5.2/5.6mmD x 8-18mmL	V	V
	TD1511	Three Step Drill Short	V	
	DL1320	Pilot Drill 2mmD x 6-13mmL	V	
	DL1328	Twist Step Drill 2.3/2.8mmD x 6-13mmL	V	
	DL1332	Twist Step Drill 2.8/3.2mmD x 6-13mmL	V	
	DL1336	Twist Step Drill 3.2/3.6mmD x 6-13mmL	V	
	DL1342	Twist Step Drill 3.6/4.2mmD x 6-13mmL	V	
	DL1346	Twist Step Drill 4.2/4.6mmD x 6-13mmL	V	
	DL1352	Twist Step Drill 4.6/5.2mmD x 6-13mmL	V	
	DL1356	Twist Step Drill 5.2/5.6mmD x 6-13mmL	V	
Parallel Pins				
	RS6150	Parallel Pin Short 11 (qty.4)	V	V
	RS6155	Parallel Pin Long 16 (qty.2)	V	V
Insertion Tools				
	UF0068	UniFit Star Handpiece Adapter - Short	V	V
	UF0071	UniFit Star Handpiece Adapter - Medium	V	V
	UF0074	UniFit Star Handpiece Adapter - Long	V	V
Drivers				
	UF0067	UniFit Star Torque Driver - Short	V	V
	UF0066	UniFit Star Torque Driver - Long	V	V
	RP0064	Star Hand Driver - Short	V	V
	RP0004	Star Hand Driver - Long	V	V
Surgical Tools				
	RS6111	Surgical Torque Ratchet 35-100 Ncm	V	V
	RA0050	Wrench Ratchet Surgical Instruments Handle	V	V
	RS6180	Depth Probe	V	V
Accessories				
	UF3401	UniFit Ratchet Retrieval tool for abutments	V	V
	RS9027	Drill Extension	V	V

UniFit Standard Internal Star Surgical Kit-Premium UF6301



Drills	Catalog
Tip Drill	RS8032
Three Step Drill-Long	TD2218
Pilot Drill 2mmD x 8-18mmL	DL1820
Twist Step Drill 2.3/2.8mmD x 8-18mmL	DL1828
Twist Step Drill 2.8/3.2mmD x 8-18mmL	DL1832
Twist Step Drill 3.2/3.6mmD x 8-18mmL	DL1836
Twist Step Drill 3.6/4.2mmD x 8-18mmL	DL1842
Twist Step Drill 4.2/4.6mmD x 8-18mmL	DL1846
Twist Step Drill 4.6/5.2mmD x 8-18mmL	DL1852
Twist Step Drill 5.2/5.6mmD x 8-18mmL	DL1856
Three Step Drill-Short	TD1511
Pilot Drill 2mmD x 6-13mmL	DL1320
Twist Step Drill 2.3/2.8mmD x 6-13mmL	DL1328
Twist Step Drill 2.8/3.2mmD x 6-13mmL	DL1332
Twist Step Drill 3.2/3.6mmD x 6-13mmL	DL1336
Twist Step Drill 3.6/4.2mmD x 6-13mmL	DL1342
Twist Step Drill 4.2/4.6mmD x 6-13mmL	DL1346
Twist Step Drill 4.6/5.2mmD x 6-13mmL	DL1352
Twist Step Drill 5.2/5.6mmD x 6-13mmL	DL1356

Surgical Tools	Catalog
Wrench Ratchet Surgical Instruments Handle	RA0050
Surgical Torque Ratchet 35-100 Ncm	RS6111
Depth Probe	RS6180

Parallel Pin	Catalog
Parallel Pin Short 11mm (qty. 4)	RS6150
Parallel Pin Long 16mm (qty. 2)	RS6155

Insertion Tools	Catalog
UniFit Star Handpiece Adapter - Short	UF0068
UniFit Star Handpiece Adapter - Medium	UF0071
UniFit Star Handpiece Adapter - Long	UF0074

Drivers	Catalog
Star Hand Driver - Short	RP0064
Star Hand Driver - Long	RP0004
UniFit Star Torque Driver - Short	UF0067
UniFit Star Torque Driver - Long	UF0066

Drill Extension	Catalog
Drill Extension	RS9027
UniFit Ratchet Retrieval Tool For Abutments	UF3401

*Products may be ordered separately as an addition to the kit

UniFit Standard Internal Star Surgical Kit-Advanced UF6322



Drills	Catalog
Tip Drill	RS8032
Three Step Drill-Long	TD2218
Pilot Drill 2mmD x 8-18mmL	DL1820
Twist Step Drill 2.3/2.8mmD x 8-18mmL	DL1828
Twist Step Drill 2.8/3.2mmD x 8-18mmL	DL1832
Twist Step Drill 3.2/3.6mmD x 8-18mmL	DL1836
Twist Step Drill 3.6/4.2mmD x 8-18mmL	DL1842
Twist Step Drill 4.2/4.6mmD x 8-18mmL	DL1846
Twist Step Drill 4.6/5.2mmD x 8-18mmL	DL1852
Twist Step Drill 5.2/5.6mmD x 8-18mmL	DL1856

Surgical Tools	Catalog
Wrench Ratchet Surgical Instruments Handle	RA0050
Surgical Torque Ratchet 35-100 Ncm	RS6111
Depth Probe	RS6180

Paraller Pin	Catalog
Parallel Pin Short 11mm (qty. 4)	RS6150
Parallel Pin Long 16mm (qty. 2)	RS6155

Inserion Tools	Catalog
UniFit Star Handpiece Adapter - Short	UF0068
UniFit Star Handpiece Adapter - Medium	UF0071
UniFit Star Handpiece Adapter - Long	UF0074

Drivers	Catalog
Star Hand Driver - Short	RP0064
Star Hand Driver - Long	RP0004
UniFit Star Torque Driver - Short	UF0067
UniFit Star Torque Driver - Long	UF0066

Drill Extension	Catalog
Drill Extension	RS9027
UniFit Ratchet Retrieval tool for abutments	UF3401

*Products may be ordered separately as an addition to the kit

Drills & Tools

Our DLC (Diamond-like Carbon) Tri-Step/Twist Step Surgical Drills are designed for a simpler, faster, and safer surgical drilling experience.

Here are the benefits:

- Simplify the cutting process, save time, and minimize risks with our Tri-Step & Twist-Step DLC drills.
- Improved DLC drill coating provides state-of-the-art hardness and slickness, increasing the lifespan of the drill, maintaining sharpness for extended drilling, and generating less heat. This reduces the chances of heating the bone or complications arising from conventional drilling protocols.
- Available in diameters ranging from 2.0 mm to 5.6 mm.
- Specially designed for Adin's implants and suitable for Adin's simple and convenient drilling protocol.
- Clearly and conveniently marked and can be used with or without drill stops.

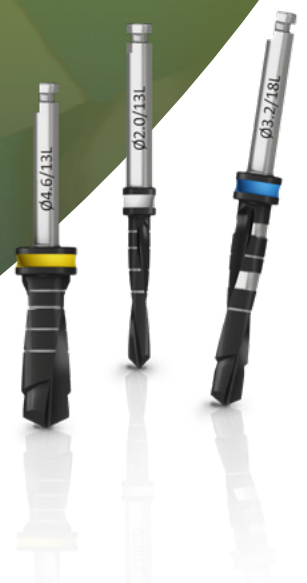



Tri-Step Drills





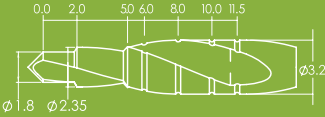

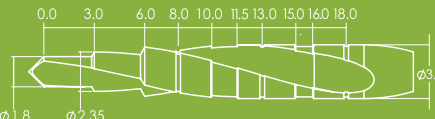

Adin's Tri-Step Drills condense drilling protocols and avoid the need for multiple drills throughout complex procedures.

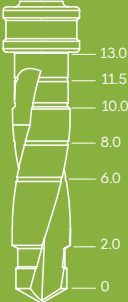
Since friction at the cutting site is reduced, complications common with high-speed drilling are decreased and faster & better recovery can occur.

The drills are designed to reduce friction at the cutting site, therefore leading to a decrease in complications that are often associated with high-speed drilling. This can result in a faster and more efficient recovery for patients.

	L	Ø	Size	Catalog
		1.8-3.2	short	TD1511
		1.8-3.2	long	TD2218

Twist Step Drills

	L	Ø	Color	Catalog
		2.0	white	DL1320
		1.8-2.5	purple	DL1325
		2.3-2.8	red	DL1328
		2.8-3.2	blue	DL1332
		3.2-3.6	green	DL1336
		3.8-4.2	black	DL1342
		4.2-4.6	yellow	DL1346
		4.8-5.2	brown	DL1352
		5.2-5.6	grey	DL1356

	L	Ø	Color	Catalog
	<p>long</p> <p>8-18mm</p>	2.0	white	DL1820
		1.8-2.5	purple	DL1825
		2.3-2.8	red	DL1828
		2.8-3.2	blue	DL1832
		3.2-3.6	green	DL1836
		3.8-4.2	black	DL1842
		4.2-4.6	yellow	DL1846
		4.8-5.2	brown	DL1852
		5.2-5.6	grey	DL1856

Tools

	Catalog
	Surgical Torque Ratchet 35-100 Ncm RS6111
	Prosthetic Torque Ratchet 15-35 Ncm RS6112
	Wrench Ratchet RS6100
	Surgical Driver RS7001
	Depth Probe RS6180

Torque Drivers

		L	Catalog
	UniFit Star Torque Driver Short	24.2	UF0067

		L	Catalog
	UniFit Star Torque Driver Long	29.2	UF0066

For angled TMA/TMA prosthetic screws		L	Catalog
	Star Torque Driver Short	20.4	RP0065

For angled TMA/TMA prosthetic screws		L	Catalog
	Star Torque Driver - Long	25.4	RP0005

For straight TMA		L	Catalog
	TMA/FC Hex Torque Driver - Short	20.0	RS6197

For straight TMA		L	Catalog
	TMA/FC HexTorque Driver Long	25.0	RS6196

		L	Catalog
	Torque Driver for Ball Attachment	14.4	RS6090

		L	Catalog
	Wrench Ratchet Surgical Instruments Handle	17	RA0050

Handpiece Adapters

		L	Catalog
	UniFit Star Handpiece Adapter - Short	25.0	UF0068

		L	Catalog
	UniFit Star Handpiece Adapter - Medium	27.6	UF0071

		L	Catalog
	UniFit Star Handpiece Adapter - Long	35.9	UF0074

Handpiece Adapters

For angled TMA/TMA prosthetic screws		L	Catalog
	Star Handpiece Driver - Short	25.0	RP0018

For angled TMA/TMA prosthetic screws		L	Catalog
	Star Handpiece Driver - Long	30.0	RP0019

For straight TMA		L	Catalog
	TMA/FC Hex Handpiece Adapter - Short	20.0	RS6194

For straight TMA		L	Catalog
	TMA/FC Hex Handpiece Adapter - Long	25.0	RS6195A

Hand Drivers

For angled TMA/TMA prosthetic screws		L	Catalog
	TMA/FC Hex Handpiece Adapter - Short	23.4	RP0064

For angled TMA/TMA prosthetic screws		L	Catalog
	TMA/FC Hex Handpiece Adapter - Long	28.4	RP0004

For straight TMA		L	Catalog
	TMA/FC Female Hand Hex Driver - Short	22.4	RS6193

For straight TMA		L	Catalog
	TMA/FC Female Hand Hex Driver Long	28.4	RS6191

Retrieval Tool

		L	Catalog
	UniFit Ratchet Retrieval Tool for Abutments	32	UF3401



Guided Surgery

Introducing the adinguide™: a guided surgery tool designed to enhance your clinic.

Our kits are tailored to support effortless and precise implant placement. With our proprietary ActiveFlow™ Irrigation technology, where coolant is efficiently delivered to the bone, preventing overheating.

The adinguide™ drills feature carved channels for direct coolant flow from your hand-piece to the osteotomy site. Our intuitive drill kit accommodates different implant sizes and lengths, while the tissue punch and pilot drill allow flapless access.

The keyless procedure offers easy handling and clear visibility of the surgical site.

Our self-centering drills utilize a diameter cylinder at the top to ensure accurate positioning within the guide's sleeve. Additionally, built-in stoppers guarantee precise and consistent drilling depths.



Guided Surgery Kit

Implants Drills | GSK001



For fully guided procedures:



Unified Conical
Implant Platform



GS Tools
Kit UniFit
GSK005



5.5mmD Sleeve
GS0055



GS5055 Tissue Punch 5.0mmD, S-5.5



GS0825 Drill S-5.5, 2.5/1.8mmDx8.0mmL



GS1325 Drill S-5.5, 2.5/1.8mmDx13.0mmL



GS0625 Pilot Drill S-5.5, 2.5/1.8mmDx6.0mmL



GS1025 Drill S-5.5, 2.5/1.8mmDx10.0mmL



GS1625 Drill S-5.5, 2.5/1.8mmDx16.0mmL



GS1125 Drill S-5.5, 2.5/1.8mmDx11.5mmL

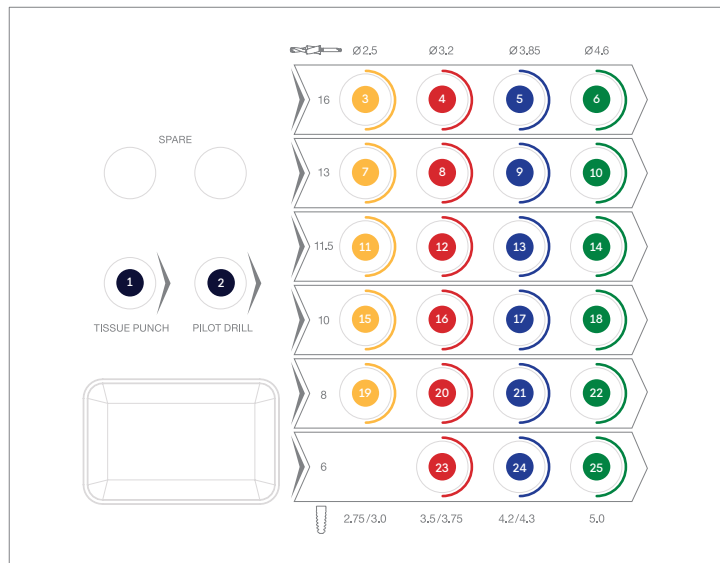

GS0632 Drill S-5.5, 3.2/2.5mmDx6.25mmL



GS0638 Drill S-5.5, 3.85/3.2mmDx6.25mmL



GS0646 Drill S-5.5, 4.6/3.85mmDx6.25mmL



GS0832 Drill S-5.5, 3.2/2.5mmDx8.0mmL

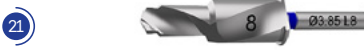

GS0838 Drill S-5.5, 3.85/3.2mmDx8.0mmL



GS0846 Drill S-5.5, 4.6/3.85mmDx8.0mmL



GS1032 Drill S-5.5, 3.2/2.5mmDx10.0mmL



GS1038 Drill S-5.5, 3.85/3.2mmDx10.0mmL



GS1046 Drill S-5.5, 4.6/3.85mmDx10.0mmL



GS1132 Drill S-5.5, 3.2/2.5mmDx11.5mmL



GS1138 Drill S-5.5, 3.85/3.2mmDx11.5mmL



GS1146 Drill S-5.5, 4.6/3.85mmDx11.5mmL



GS1332 Drill S-5.5, 3.2/2.5mmDx13.0mmL



GS1338 Drill S-5.5, 3.85/3.2mmDx13.0mmL



GS1346 Drill S-5.5, 4.6/3.85mmDx13.0mmL



GS1632 Drill S-5.5, 3.2/2.5mmDx16.0mmL



GS1638 Drill S-5.5, 3.85/3.2mmDx16.0mmL



GS1646 Drill S-5.5, 4.6/3.85mmDx16.0mmL

Guided Surgery Tools Kit UniFit Implants | GSK005



For fully guided procedures:



Unified Conical
Implant Platform



GS Drills Kit
GSK001



5.5mmD Sleeve
GS0055

1

GS1915 

Anchoring Drill S-2.0, 2.0/1.5mmDx19mmL

2

GS1917 

Anchoring Drill S-2.0, 2.0/1.7mmDx19mmL

3

GS0028 

Handpiece Guide Fixation Screw Driver

4

GS5041 

Guided UniFit Handpiece Fixture Mount S-5.5

5

GS5043 

Guided UniFit Ratchet Fixture Mount S-5.5

6

GS5037 

Guided UniFit Ratchet Fixture Mount S-5.5, Screw Retained (qty.4)

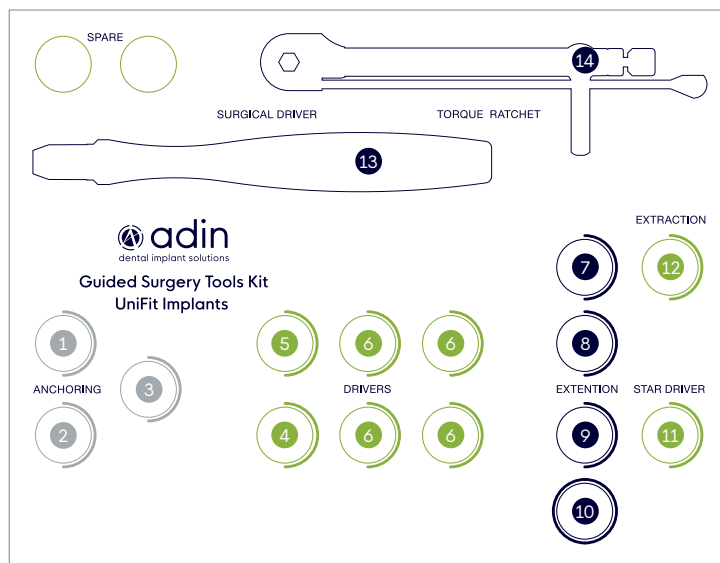

7

GS0023 

Manual Socket L10.5

9

GS0021 

Handpiece Socket L10.5

11

RP0004 

Star Hand Driver - Long

8

GS0024 

Manual Socket L14.5

10

GS0022 

Handpiece Socket L14.5

12

GS5046 

UniFit Ratchet Retrieval Tool

13

GS0027 

Guide Fixation Screw Driver (Surgical Driver)





14

GS6111 





Surgical Torque Ratchet 35-100 Ncm for hex 4mm

Components

Accessories

			Catalog
	Guided Vertical Fixation Screw S-5.5	x 3 pack	GS0007
	2.0mmD Anchoring Screw	x 3 pack	GS1920
	5.5mmD Sleeve	x 1 pack	GS0055
		x 3 pack	GS0055x3
		x 10 pack	GS0055x10
	2.0mmD Anchoring Sleeve	x 3 pack	GS0020

18mm Drills

	Drill S-5.5, 2.5/1.8mm Dx18.0mmL	Catalog	GS1825
	Drill S-5.5, 3.2/2.5mmD x18.0mmL	Catalog	GS1832
	Drill S-5.5, 3.85/3.2mmD x18.0mmL	Catalog	GS1838
	Drill S-5.5, 4.6/3.85mmD x18.0mmL	Catalog	GS1846

CONDICIONES GENERALES DE VENTA

El horario telefónico de nuestro departamento de Atención al Cliente es de lunes a viernes de 9:30 a 18:00 h y la tramitación de pedidos se realiza de lunes a viernes de 9:30 a 16:30 h.

Desde el 15 de julio y hasta el 31 de agosto, ambos incluidos, nuestro horario de verano será de lunes a viernes de 9:30 a 15:00 h y la tramitación de pedidos se realizará de lunes a viernes de 9:30 a 14:00 h. Los pedidos recibidos durante este horario serán entregados en un plazo máximo de dos días laborables (en el caso de nuevos clientes, el procedimiento de alta podría incrementar este plazo).

Los pedidos de más de 50 unidades serán servidos en el plazo de una semana. En pedidos por importe superior a 180 € se abonarán los gastos de envío, los cuales ascienden a 8,95 € (IVA no incluido). Al comprar en nuestras tiendas online, los gastos de envío se abonarán en compras superiores a 100 €, estos gastos ascienden a 8,95 € (IVA no incluido).

Los posibles cambios de material podrán ser realizados dentro de un plazo máximo de 6 meses desde la fecha del pedido, con un cargo equivalente a los gastos de tramitación y envío.

No se aceptarán devoluciones transcurridos 6 meses de la fecha del pedido y es requisito indispensable adjuntar la copia de la factura o el albarán correspondiente al material retornado.

En ningún caso se aceptará material que haya sido manipulado, con empaque deteriorado, caducado o con fecha de caducidad inferior a 6 meses. No se aceptarán devoluciones de material que formen parte de una oferta o de una bonificación. El retorno de material a Adin Ibérica, como cambio o devolución, es a cargo y cuenta del cliente.



www.adin-iberica.com
info@adin-iberica.com

Fabricado por:
Adin Dental Implant
Systems Ltd.
Industrial Zone Alon
Tavor POB 1128,
Afula 18550, Israel

Distribuido por:
Adin Ibérica Dental
Sancllemente Nº25, 4º dcha.
50001, Zaragoza
T. +34 976 51 59 41

Importado por:
Araganey Dental
Plaza San Luis Gonzaga nº7, PB3.
08950, Esplugues de Ll.
T. +34 934 19 47 70

