



CloseFit™

# Narrow Implants



CloseFit™

# Narrow Implants

When you're seeking to minimize micro-movements between the dental implant and the abutment and to reduce potential bone loss, you'll benefit from Adin's CloseFit™ spiral implant system, which features an extremely strong, stable and solid conical-hex connection.

The CloseFit's tapered core implant includes a multi-lead active & dynamic thread design. The unique design of the implant is suited for optimal repositioning at diverse angles within the lower and upper jaw. Designed for subcrestal placement up to 1.0 - 2.0mm.

The CloseFit™ implants feature Adin's OsseoFix™ - A biocompatible surface treatment that uses gritting with Calcium Phosphate media that is debris free and has been designed to achieve the desired roughness levels needed for optimal osseointegration.

With more than 10 years of proven clinical experience, these uniquely designed small diameter implants of 2.75mm & 3.0mm, have an especially narrow body & collar to provide a perfect solution that addresses narrow ridges in atrophic jaws for exceptional aesthetic results.

The strong Conical Connection is designed to minimize micro movements.

## UNP CloseFit™

Ø 2.75mmD  
Ultra Narrow Platform

Optimally designed for narrow ridges, minimize the need for bone augmentation

### OsseoFix™ Surface

Triple lead thread with 3.0mm (3x1mm)  
For fast efficient insertion

## NP CloseFit™

Ø 3.0mmD  
Narrow Platform

\* Platform Switching

\* Micro Threads:  
Engineered to enhance bone regeneration, prevent bone loss & increase bone implant contact

Double lead threads  
2.4mm (2x1.2mm)  
For fast efficient insertion

\* Length

L-10mm | L-11.5mm | L-13 mm  
L-16mm | L-18 mm

\*The features related to UNP & NP Implants

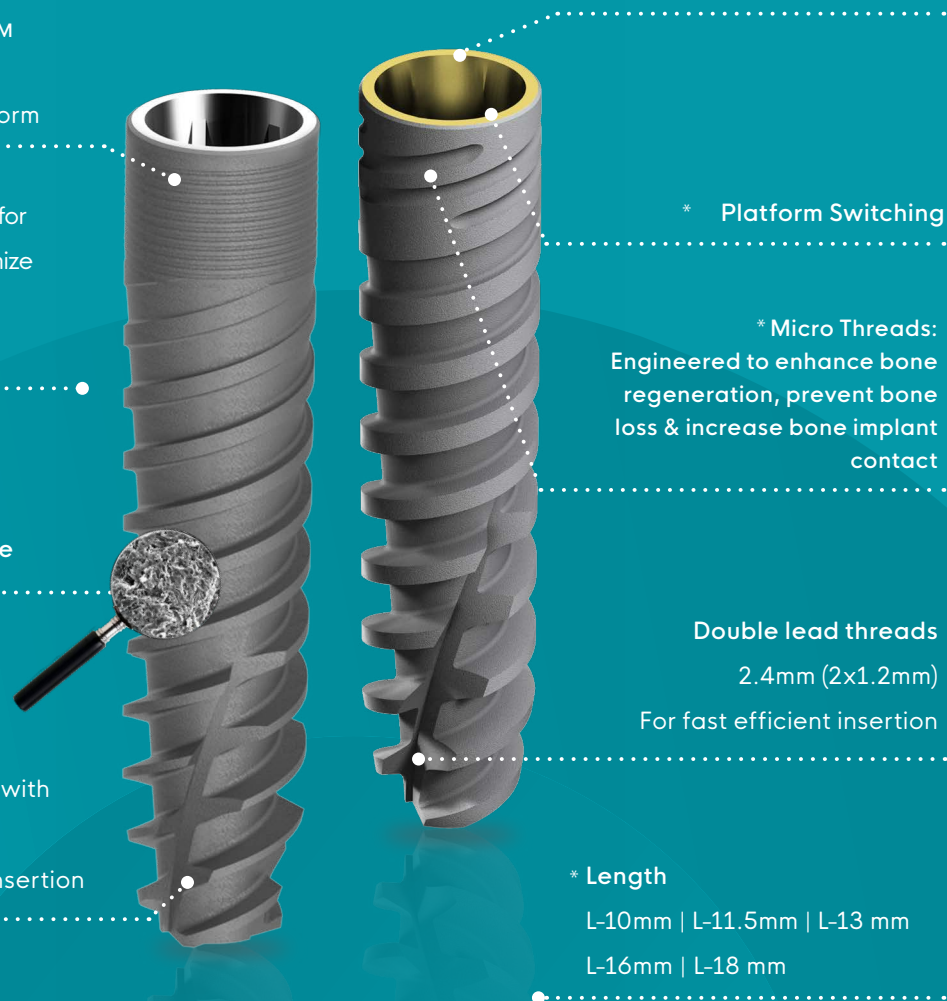

# UNP Ultra Narrow Platform

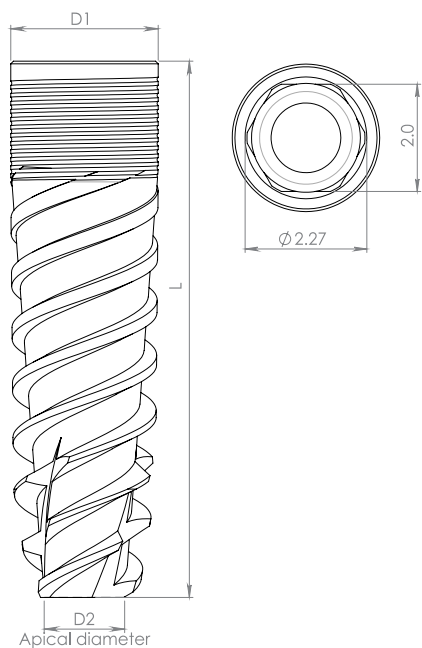

Recommended insertion torque up to 50 Ncm

	D1	L	D2	Catalog No.
	2.75	10.0	1.5	ISPUNP1027
		11.5	1.5	ISPUNP1127
		13.0	1.5	ISPUNP1327
		16.0	1.5	ISPUNP1627
		18.0	1.5	ISPUNP1827

Radiographic Template UNP CloseFit™ | ASD0615

## Drill Sequence for UNP Recommended drilling speed up to 1200 rpm

Implant Diameter  $\varnothing 2.75$

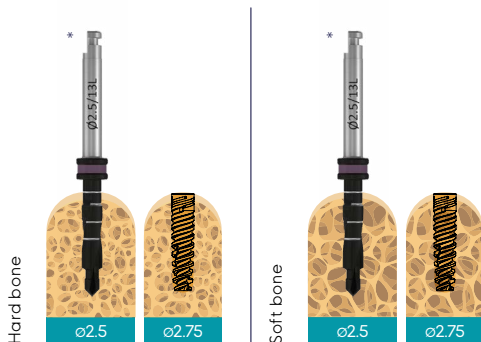

All measurements are in mm

\*Products may be ordered separately as an addition to the kit

Note: (x.xx) Drill to the depth of the cortex only. All measurements are in mm.

⚠ CAUTION: The drill preparation is up to 1mm longer than the implant.

\* The drill apical step = 1.8mmD.

# NP Narrow Platform

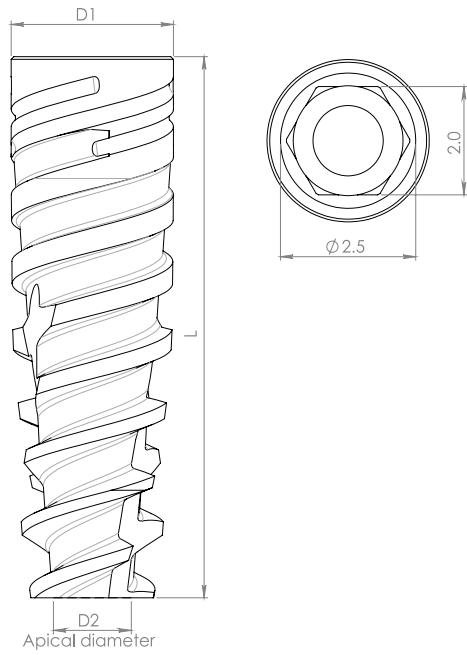

Recommended insertion torque up to 50 Ncm

	D1	L	D2	Catalog No.
	3.0	10.0	1.5	ISPNP1030
		11.5	1.5	ISPNP1130
		13.0	1.5	ISPNP1330
		16.0	1.5	ISPNP1630
		18.0	1.5	ISPNP1830

Radiographic Template NP CloseFit™ | ASD0611

## Drill Sequence for NP Recommended drilling speed up to 1200 rpm

Implant Diameter  $\varnothing 3.0$   $\varnothing 3.0$

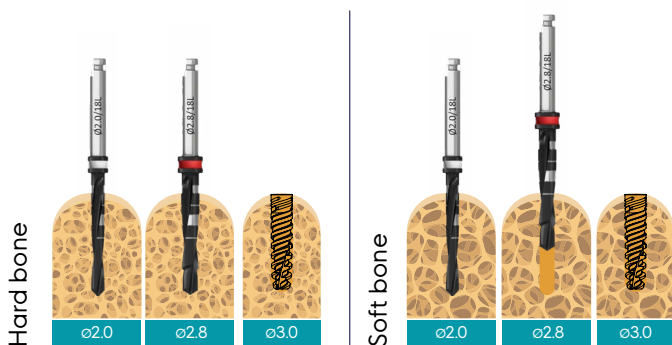

All measurements are in mm.

Note: (x.xx) Drill to the depth of the cortex only.





**⚠ CAUTION:** The drill preparation is up to 1mm longer than the implant. \* The drill apical step = 1.8mmD.

# Cover Screw & Healing Abutments

Recommended Torque 15(Ncm)

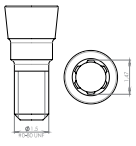

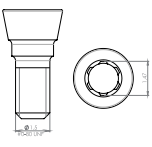
## Cover Screw Packed with implant

		Description	Catalog No.
		UNP CloseFit™ Conical Cover Screw	UNP0073
		NP CloseFit™ Conical Cover Screw	NP0073

## Healing Abutments

		Description	∅	GH	Catalog No.
		UNP CloseFit™ Slim Healing Abutment	2.75	2.0	UNP0046
			2.75	3.0	UNP0047
			2.75	4.0	UNP0048
			2.75	5.0	UNP0049
			2.75	6.0	UNP0050
		UNP CloseFit™ Healing Abutment	4.0	2.0	UNP0004
			4.0	3.0	UNP0008
			4.0	4.0	UNP0009
			4.0	5.0	UNP0012
			4.0	6.0	UNP0013
		UNP CloseFit™ Conical Healing Abutment	4.0	2.0	UNP0090
			4.0	3.0	UNP0091
			4.0	4.0	UNP0092
			4.0	5.0	UNP0093
			4.0	6.0	UNP0094
		NP CloseFit™ Slim Healing Abutment	3.0	2.0	NP0046
			3.0	3.0	NP0047
			3.0	4.0	NP0048
			3.0	5.0	NP0049
			3.0	6.0	NP0050
		NP Wide Healing Abutment	4.5	2.0	NP0004
			4.5	3.0	NP0008
			4.5	4.0	NP0009
			4.5	5.0	NP0012
			4.5	6.0	NP0013
		NP Conical Healing Abutment	4.5	2.0	NP0090
			4.5	3.0	NP0091
			4.5	4.0	NP0092
			4.5	5.0	NP0093
			4.5	6.0	NP0094

# Impression Recommended Torque 15(Ncm)

Our components for taking impressions for all restoration types can be successfully utilized for digital or conventional protocols either implant-level or abutment level procedures.

Our broad range of solutions and flexible designs enable easy and accurate restorative planning, whether you're dealing with a single tooth, multiple teeth, bridge or full mouth rehabilitation.



## UNP Transfers | Recommended Torque 15(Ncm)

	Open Tray	Description	L	D1	H	Catalog No.		Close Tray	Description	L	D1	H	Catalog No.
		UNP Open Tray Transfer Short	20.0	6.0	12.0	UNP5613			UNP Close Tray Transfer Short	11.0	3.2	9.0	UNP5711
		UNP Open Tray Transfer Long	23.5	6.0	15.0	UNP5617			UNP Close Tray Transfer Long	15.0	3.2	13.0	UNP5715

## NP Transfers | Recommended Torque 15(Ncm)

	Open Tray	Description	L	D1	H	Catalog No.		Close Tray	Description	L	D1	H	Catalog No.
		NP Open Tray Transfer Short	20.0	6.0	12.0	NP5411			NP Close Tray Transfer Short	10.7	3.5	9.0	NP5311
		NP Open Tray Transfer Long	23.4	6.0	15.0	NP5415			NP Close Tray Transfer Long	15.0	3.5	13.0	NP5315

## UNP Scan Bodies

	Description	H	Catalog No.		Description	H	Catalog No.
	UNP Scan Body	7	UNP0088		UNP Scan Body	10	UNP0089

## NP Scan Bodies

	Description	H	Catalog No.		Description	H	Catalog No.
	NP Scan Body	7	NP0088		NP Scan Body	10	NP0089

## UNP Analogs

	Description	L	D1	Catalog No.		Description	Catalog No.		Description	L	D1	Catalog No.
	UNP Digital Analog 15(Ncm)	10.0	3.55	UNP1000		Retaining Screw	RS1002		UNP Implant Analog	12.6	3.6	UNP0007

## NP Analogs

	Description	L	D1	Catalog No.		Description	Catalog No.		Description	L	D1	Catalog No.
	NP Digital Analog 15(Ncm)	10.0	3.55	NP1000		Retaining Screw	RS1002		NP Implant Analog	12.6	3.6	NP0007

## Temporary & Cement Retained Restoration



Recommended Torque 35(Ncm)





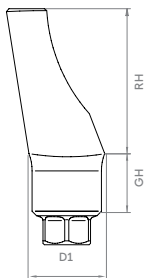

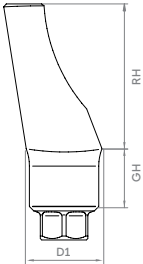



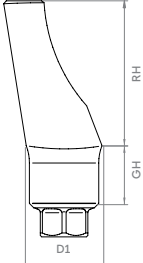

## UNP Abutments

	Description	D1	GH	RH	Catalog No.
	UNP Non Engaging Temporary Abutment	3.70	2.00	8.00	UNP0044
	UNP Engaging Temporary Abutment	3.70	2.00	8.00	UNP0043
	UNP Straight Slim Abutment No End Line	3.50	1.00	7.30	UNP0010
	UNP Straight Abutment	4.20	1.00	6.50	UNP0019
		4.20	2.00	6.50	UNP0011
		4.20	3.00	6.50	UNP0064
	UNP Angled Abutment 15° No End Line	3.50	1.00	6.10	UNP0018
	UNP Angled Abutment 15°	4.20	1.00	6.50	UNP0063
		4.20	2.00	6.50	UNP0015
		4.20	3.00	6.50	UNP0026
	UNP One Piece Screw in Abutment	3.50	1.10	9.30	UNP3812
		3.50	2.00	9.30	UNP3813
		3.50	3.00	9.30	UNP3814
	UNP Engaging Plastic Cylinder Abutment	3.70	2.00	8.00	UNP0045



		Description	D1	GH	RH	Catalog No.
		UNP Engaging Cobalt Chrome/ Plastic Abutment	3.70	2.00	8.00	UNP3094
		UNP Non-Engaging Cobalt Chrome/ Plastic Abutment	3.70	2.00	8.00	UNP3100

## NP Abutments

		Description	D1	GH	RH	Catalog No.
		NP Engaging Temporary Abutment	3.7	0.7	8.0	NP0043
		NP Non-Engaging Temporary Abutment	3.7	0.7	8.0	NP0044
		NP Straight Slim Abutment No End Line	3.5	3.2	5.7	NP0010
		NP Straight Abutment	4.4	1.0	6.5	NP0019
			4.4	2.0	6.5	NP0011
			4.4	3.0	6.5	NP0064
		NP Angled Abutment 15° No End Line	4.3	1.4	8.2	NP0018
		NP Angled Abutment 15°	4.8	1.0	6.5	NP0015
			4.8	2.0	6.5	NP0026
			4.8	3.0	6.5	NP0063
		NP Angled Abutment 25° No End Line	3.8	1.6	6.5	NP0025
		NP Engaging Plastic Cylinder Abutment (Casting)	3.7	0.7	8.0	NP0045
		NP Engaging Cobalt Chrome/ Plastic Abutment	4.2	1.0	10.0	NP3094
		NP Engaging Titanium/ Plastic Abutment (Casting)	4.2	1.0	10.0	NP3095
		NP Non-Engaging Titanium / Plastic Abutment (Casting)	4.2	1.0	10.0	NP3097

# Iris™ Snap - on for UNP and NP

Adin's Snap-on impression is an effective and easy option for both implant level and abutment level impression copying. Plastic pickup cap placed over a precision machined abutment allows for accurate coping utilizing closed tray impression. Adin's Snap-on range aims to allow flexibility by offering various options to match users preferred method of use through pre packed kits:

- IRIS™ Kit - abutment level impression and restoration set
- Snap-on impression kit - implant level impression



## UNP Iris™ Kit



Description	RH	GH	Catalog No.
Iris™ UNP CloseFit™ Kit	4	1	IR6041
		2	IR6042
		3	IR6043
		4	IR6044
	6	1	IR6061
		2	IR6062
		3	IR6061
		4	IR6062
	8	1	IR6063
		2	IR6064
		3	IR6081
		4	IR6082

## UNP Snap-on Impression Kit



Description	RH	GH	Catalog No.
Iris™ UNP Snap-on Impression Kit	4	1	IR6141
		2	IR6142
		3	IR6143
		4	IR6144
	6	2	IR6262
		4	IR6264

## UNP Snap-on Impression Pack



Description	RH	GH	Catalog No.
Iris™ UNP Abutment	4	1	IR0641
		2	IR0642
		3	IR0643
		4	IR0644
	6	1	IR0661
		2	IR0662
		3	IR0663
		4	IR0664
	8	1	IR0681
		2	IR0682

## NP Iris™ Kit



Description	RH	GH	Catalog No.
Iris™ NP CloseFit™ Kit	4	1	IR2041
		2	IR2042
		3	IR2043
		4	IR2044
	6	1	IR2061
		2	IR2062
		3	IR2063
		4	IR2064
	8	1	IR2081
		2	IR2082

## NP Snap-on Impression Kit







Description	RH	GH	Catalog No.
Iris™ NP Snap-on Impression Kit	4	1	IR2141
		2	IR2142
		3	IR2143
		4	IR2144
	6	2	IR2262
		4	IR2264



## NP Snap-on Impression Pack



Description	RH	GH	Catalog No.
Iris™ NP Abutment	4	1	IR0241
		2	IR0242
		3	IR0243
		4	IR0244
	6	1	IR0261
		2	IR0262
		3	IR0263
		4	IR0264
	8	1	IR0281
		2	IR0282

## Purchase Options

	Description	RH	Catalog No.
	UNP Implant Analog	-	UNP0007
	NP Implant Analog	-	NP0007
	Iris™ Abutment replica	4	IR0404
		6	IR0406
		8	IR0408
	Iris™ PEEK Comfort cap	4	IR0180
		6	IR0181
		8	IR0189



	Description	Qty	Catalog No.
	Iris™, Burnout anti rotation cap red	1	IR0182
		4	IR0185
	Iris™, Burnout cap white	4	IR0183
		6	IR0186
	Iris™, Impression coping	1	IR0179
		4	IR0184

# Narrow Screw - Retained











Recommended Torque 35(Ncm)



## UNP Screws

	Description	L	Ø	Catalog No.
	UNP Abutment Screw	7.90	2.00	UNP0001
	UNP Closed Tray Transfer Screw	20.00	2.80	UNP5127
	UNP Open Tray Transfer Screw	28.00	3.10	UNP5014

## NP Screws

	Description	L	Ø	Catalog No.
	NP Abutment Screw	7.9	2.0	NP0001
	TMA Prosthetic Screw 15(Ncm)	4.1	2.1	RS3404
	NP Retaining Screw for Angled TMA	7.1	2.0	NP0042
	NP Retaining Screw for TMA 1mm	8.0	3.1	NP0039
	NP Retaining Screw for TMA 2mm	9.0	3.1	NP0040
	NP Retaining Screw for TMA 3mm	10.0	3.1	NP0041
	NP Retaining Screw for TMA 4mm	11.0	3.1	NP3409
	NP Retaining Screw for TMA 5mm	12.0	3.1	NP3412
	NP Open Tray Transfer Screw	28.0	3.1	NP5014
	NP Closed Tray Transfer Screw	20.0	2.8	NP5127
	NP Retrieval Screw for Abutments	13.4	2.0	NP0014

# NP Single TMA™ Recommended Torque 35(Ncm)

Adding to Adin's variety of the screw-retained restoration range, in comes the single TMA. Utilizing all the benefits of the TMA abutments while allowing the accuracy and flexibility for single tooth restoration.

Adin's STMA offers the possibility to combine the benefits of trans-gingival approach and screw-retained single tooth restoration yielding greater flexibility in both esthetics, safety and restoration maintenance. Adin's Single TMA is based on the TMA abutment, while the added hex index offers both the required accurate positioning and retention to support a single tooth crown. Open and closed tray transfers as well as scan bodies for digital impression are available to match every preferred impression method as well as replicas for straight forward and simple work process.



		Description	GH	Catalog No.
		NP Straight Single TMA Abutment 1mm	1.0	NP0032S
		NP Straight Single TMA Abutment 2mm	2.0	NP0033S
		NP Straight Single TMA Abutment 3mm	3.0	NP0034S
		NP Straight Single TMA Abutment 4mm	4.0	NP3729S
		NP Straight Single TMA Abutment 5mm	5.0	NP3730S
		NP Angled Single TMA Abutment 17° 3mm	2.8	NP0035S
		NP Angled Single TMA Abutment 17° 4mm	3.9	NP0038S
		NP Angled Single TMA Abutment 30° 3.5mm	3.4	NP0036S
		NP Angled Single TMA Abutment 30° 5mm	4.9	NP0037S

## Transfers

	Description	L	D1	D2	Catalog No.		Description	L	D1	D2	Catalog No.
	Single TMA Impression Coping Open Tray	11.0	4.9	3.1	RS5006S		Single TMA Closed Tray Transfer	8.0	4.9	4.1	RS5011S

## Snap-On

	Description	L	D1	D2	Catalog No.		Description	Catalog No.
	Single TMA Snap-On Transfer	8.0	4.9	3.2	RS5012S		IRIS™, Impression coping	IR0179





## Analogs

	Description	L	D1	Catalog No.		Description	L	D1	D2	Catalog No.
	Single TMA Abutment Replica	16.8	3.35	RS5004S		Single TMA Digital Model Replica Recommended torque 15(Ncm)	12.0	4.9	3.8	RS1001S

## Scan Bodies

	Description	L	D1	Catalog No.
	Single TMA Scan Body	6.0	4.9	TM0006S
		9.0	4.9	TM0009S

## STMA Prosthetics

	Description	L	D1	D2	H	Catalog No.
	Single TMA Titanium Temporary	12.0	4.9	3.5	10.5	RS4900S
	Single TMA Plastic Casting Sleeve w/Prosthetic Screw	12.0	4.9	3.3	10.5	RS5001S
	Single TMA Healing Cup	5.5	4.9	3.5	-	RS5005S
	Single TMA Cementing Cone, low profile	4.9	5.5	3.2	-	TM0011S





# CAD CAM

Adin's CAD - CAM components and digital libraries enable clinicians and technicians to design and manufacture state-of-the-art restorations supported by Adin's implants, using current digital restoration processes.



The variety of components ensures endless restorative options for treatment of single, multiple, partially, or fully edentulous cases.







## UNP

For Intra-oral and Desktop Scanner		H	Catalog No.	For Medentika PreFace® Holder		Ø	Catalog No.
	UNP Scan Body	7	UNP0088		UNP Ti Blank	11.5	UNP1711
		10	UNP0089			15.8	UNP1715

## NP

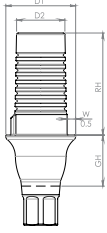

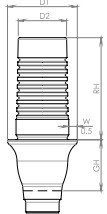

For Intra-oral and Desktop Scanner		H	Catalog No.	For Medentika PreFace® Holder		Ø	Catalog No.
	UNP Scan Body	7	NP0088		NP Ti Blank	11.5	NP1111
		10	NP0089			15.8	NP1115

## UNP Ti Base Abutments



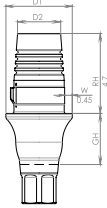

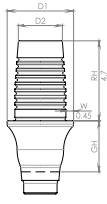
		Description	RH	GH	D1	D2	Catalog No.
		Ti Base UNP Abutment, <b>Engaged</b>	4.0	1.5	4.1	2.9	TB06411
		4.0	2.0	4.1	2.9	TB06421	
		4.0	3.0	4.1	2.9	TB06431	
		4.0	4.0	4.1	2.9	TB06441	
		6.0	1.5	4.1	2.8	TB06611	
		6.0	2.0	4.1	2.8	TB06621	
		6.0	3.0	4.1	2.8	TB06631	
		6.0	4.0	4.1	2.9	TB06641	
		8.0	1.5	4.1	2.8	TB06811	
		8.0	2.0	4.1	2.8	TB06821	
		Ti Base UNP Abutment, <b>Non Engaged</b>	4.0	1.5	4.1	2.9	TB06412
		4.0	2.0	4.1	2.9	TB06422	
		4.0	3.0	4.1	2.9	TB06432	
		4.0	4.0	4.1	2.9	TB06442	
		6.0	1.5	4.1	2.8	TB06612	
		6.0	2.0	4.1	2.8	TB06622	
		6.0	3.0	4.1	2.8	TB06632	
		6.0	4.0	4.1	2.8	TB06642	
		8.0	1.5	4.1	2.8	TB06812	
		8.0	2.0	4.1	2.8	TB06822	

## UNP C-Type Ti Base Abutments

For further product information and use please refer to IFU028

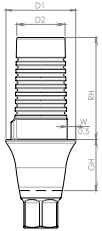

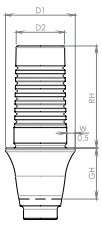

	Description	RH	GH	D1	D2	Catalog No.
	 C-Type Ti Base UNP Abutment, <b>Engaged</b>	4.7	1.5	3.9	2.5	TB06414
		4.7	2.0	3.9	2.5	TB06424
		4.7	3.0	3.9	2.5	TB06434
		4.7	4.0	3.9	2.5	TB06444
	 C-Type Ti Base UNP Abutment, <b>Non Engaged</b>	4.7	1.5	3.9	2.6	TB06415
		4.7	2.0	3.9	2.6	TB06425
		4.7	3.0	3.9	2.6	TB06435
		4.7	4.0	3.9	2.6	TB06445

## NP Ti Base Abutments

	Description	RH	GH	D1	D2	Catalog No.
	 Ti Base NP Abutment, <b>Engaged</b>	4.0	1.5	4.1	2.9	TB02411
		4.0	2.0	4.1	2.9	TB02421
		4.0	3.0	4.1	2.9	TB02431
		4.0	4.0	4.1	2.9	TB02441
		6.0	1.5	4.1	2.8	TB02611
		6.0	2.0	4.1	2.8	TB02621
		6.0	3.0	4.1	2.8	TB02631
		6.0	4.0	4.1	2.8	TB02641
		8.0	1.5	4.1	2.8	TB02811
		8.0	2.0	4.1	2.8	TB02821
	 Ti Base NP Abutment, <b>Non Engaged</b>	4.0	1.5	4.1	2.9	TB02412
		4.0	2.0	4.1	2.9	TB02422
		4.0	3.0	4.1	2.9	TB02432
		4.0	4.0	4.1	2.9	TB02442
		6.0	1.5	4.1	2.8	TB02612
		6.0	2.0	4.1	2.8	TB02622
		6.0	3.0	4.1	2.8	TB02632
		6.0	4.0	4.1	2.8	TB02642
		8.0	1.5	4.1	2.8	TB02812
		8.0	2.0	4.1	2.8	TB02822

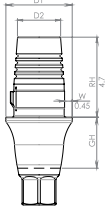
## NP C-Type Ti Base Abutments

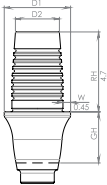
For further product information and use please refer to IFU028

	Description	RH	GH	D1	D2	Catalog No.
	 C-Type Ti Base NP Abutment, <b>Engaged</b>	4.7	1.5	3.9	2.5	TB02414
		4.7	2.0	3.9	2.5	TB02424
		4.7	3.0	3.9	2.5	TB02434
		4.7	4.0	3.9	2.5	TB02444
	 C-Type Ti Base NP Abutment, <b>Non Engaged</b>	4.7	1.5	3.9	2.6	TB02415
		4.7	2.0	3.9	2.6	TB02425
		4.7	3.0	3.9	2.6	TB02435
		4.7	4.0	3.9	2.6	TB02445



## CAD CAM | Angulated Screw Channel

The angulated screw channel (ASC) solution offers a transformative approach to dental restorations. ASC strategically places a screw access hole at an angle within the prosthesis, optimizing both function and esthetics.

By integrating digital planning and specialized drivers, ASC enhances accuracy and predictability in implant-supported restorations. This approach signifies a significant advancement in dental care, prioritizing esthetics and functionality to ensure patient satisfaction.

Adin's angulated screw channel Ti bases support gingival heights of 1-3mm for every each implant platform and allow for angulation of up to 20 degrees.

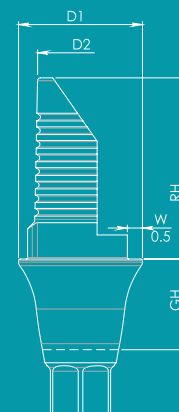

## Ti Base Abutment Angular

	RH	GH	D1	D2	Catalog No.		RH	GH	D1	D2	Catalog No.
 UNP Ti Base Abutment Angular <b>Engaged</b>	4.0	1.5	4.1	2.9	TB06413	 NP Ti Base Abutment Angular <b>Engaged</b>	4.0	1.5	4.1	2.9	TB02413
	4.0	2.0	4.1	2.9	TB06423		4.0	2.0	4.1	2.9	TB02423
	4.0	3.0	4.1	2.9	TB06433		4.0	3.0	4.1	2.9	TB02433
	6.0	1.5	4.1	2.9	TB06613		6.0	1.5	4.1	2.8	TB02613
	6.0	2.0	4.1	2.9	TB06623		6.0	2.0	4.1	2.8	TB02623
	6.0	3.0	4.1	2.9	TB06633		6.0	3.0	4.1	2.8	TB02633
	8.0	1.5	4.1	2.9	TB06813		8.0	1.5	4.1	2.8	TB02813
	8.0	2.0	4.1	2.9	TB06823		8.0	2.0	4.1	2.8	TB02823
	Abutments are supplied with UNP0001 screw. Recommended torque 25Ncm. Also available separately				UNP0001		Abutments are supplied with NP0001 screw. Recommended torque 25Ncm. Also available separately				NP0001



## Angulated Tools

	Description	L	L2	D1	D2	Catalog No.
	Angulated Screw Extractor Hand Driver	24.7	10	1.4	9.4	RP6400
	Angulated Star Screw Hand Driver - Short 23.4L	23.4	9.0	1.4	9.4	RP6401
	Angulated Star Screw Hand Driver - Long 28.4L	28.4	14.0	1.4	9.4	RP6402
	Angulated Star Screw Torque Driver - Short 17.0L	17.0	11.0	1.4	7.0	RP6403
	Angulated Star Screw Torque Driver - Long 22.0L	22.0	16.0	1.4	7.0	RP6404
	Angulated Star Screw Handpiece Driver - Extra Short 20.0L	20.0	7.0	1.4	2.35	RP6405
	Angulated Star Screw Handpiece Driver - Short 25.0L	25.0	12.0	1.4	2.35	RP6406
	Angulated Star Screw Handpiece Driver - Long 30.0L	30.0	17.0	1.4	2.35	RP6407



## Digital Analogs

	Description	L	D1	Catalog No.		Description	Catalog No.		Description	L	D1	Catalog No.
	UNP CloseFit™ Digital Analog	10.0	3.55	UNP1000		Retaining Screw	RS1002		NP CloseFit™ Digital Analog	10.0	3.55	NP1000



## Screws

	Description	Catalog No.
	UNP CloseFit™ Abutment Screw	UNP0001
	NP CloseFit™ Abutment Screw	NP0001





## TMA - Multi Unit Screws

	Description	Catalog No.
	TMA Scan Body Screw	TM0001
	TMA Prosthetic Screw	RS3404

## STMA / TMA Scan Bodies | For Intra-oral and Desktop Scanner

	Description	L	D1	Catalog No.		Description	L	D1	Catalog No.
	Single TMA Scan Body	6.0	4.9	TM0006S		TMA Scan Body	6.0	4.9	TM0006
		9.0	4.9	TM0009S			9.0	4.9	TM0009

## STMA / TMA Cementing Cone & Temporary Cylinder

	Description	L	D1	D2	H	Catalog No.		Description	L	D1	D2	Catalog No.
	Single TMA Titanium Temporary	12.0	4.9	3.5	10.5	RS4900S		Single TMA Cementing Cone, low profile	4.9	5.5	3.2	TM0011S
								TMA Cementing Cone, low profile	4.9	5.5	3.2	TM0011
	TMA Titanium Temporary	12.0	4.9	3.5	10.5	RS4900		TMA Cementing Cone	4.9	4.9	3.8	TM0010

## Tool Drivers

	Description	L	Catalog No.		Description	L	Catalog No.
	Star Hand Driver Short	23.4	RP0064		Star Hand Driver Long	28.4	RP0004

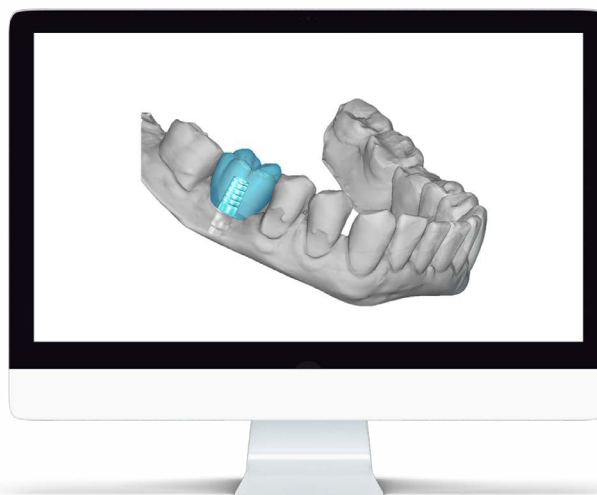

# TMA™ - Multi Unit Recommended Torque 35(Ncm)

Our TMA™ (Trans Mucosal Abutment) system is indicated for multiple-unit, screw-retained restorations, and may be used in combination with an implant-level framework design.

- Elevates restorative seating platform when implant-level restoration is not practical
- Provides better access when using implants with divergent angles
- Accommodates full and partial edentulous arches
- Available in straight or angled (17°, 30°, 45°) with different gingival heights
- Abutments are delivered with handles for easy insertion and seating



		Description	GH	Catalog No.		
		NP Straight Trans Mucosal Abutment	1.0	NP0032		
			2.0	NP0033		
			3.0	NP0034		
			4.0	NP3729		
			5.0	NP3730		
		NP Angled Trans Mucosal Abutment 17°	2.8	NP0035		
				3.9	NP0038	
					3.4	NP0036
						4.9

## Transfers

	Description	L	D1	D2	Catalog No.
	TMA Impression Coping Open Tray	11.0	4.9	3.1	RS5006
	TMA Closed Tray Transfer	8.0	4.9	4.1	RS5011
	TMA Healing Cup	5.5	4.9	3.5	RS5005

## Analogs

	Description	L	D1	D2	Catalog No.
	TMA Abutment Replica	16.8	3.35	-	RS5004
	TMA Digital Model Replica <small>Recommended torque 15(Ncm)</small>	12.0	4.9	3.8	RS1001
	Description	L	D1	Catalog No.	
	TMA Scan Body	6.0	4.9	TM0006	
		9.0	4.9	TM0009	

## TMA Screw For Scan Body & Cementing Cone

	Description	Catalog No.
	TMA Scan Body Screw	TM0001





## TMA Screw Temporary Cylinder & STMA Direct Option

	Description	Catalog No.
	TMA Prosthetic Screw	RS3404

## Snap-On

	Description	L	D1	D2	Catalog No.		Description	Catalog No.
	TMA Snap-On Transfer	8.0	4.9	3.2	RS5012		IRIS™, Impression coping	IR0179

## TMA Prosthetics

	Description	L	D1	D2	H	Catalog No.		Description	L	D1	D2	Catalog No.
	TMA Titanium Temporary	12.0	4.9	3.5	10.5	RS4900		TMA Cementing Cone, low profile	4.9	5.5	3.2	TM0011
	TMA Plastic Casting Sleeve /Prosthetic Screw	12.0	4.9	3.3	10.5	RS5001		TMA Cementing Cone	4.9	5.5	2.9	TM0010

# Overdenture Restoration

Recommended Torque 25(Ncm)



		Description	GH	RH	H	Catalog No.
		UNP Ball Attachment	0.6	2.45	3.05	UNP0020
			1.0	2.45	3.45	UNP0021
			2.0	2.45	4.45	UNP0022
			3.0	2.45	5.45	UNP0023
			4.0	2.45	6.45	UNP0024
			5.0	2.45	7.45	UNP0025
		NP Ball Attachment	0.6	2.7	4.1	NP0020
			1.0	2.7	4.5	NP0021
			2.0	2.7	5.5	NP0022
			3.0	2.7	6.5	NP0023
			4.0	2.7	7.5	NP0024

	Description	L	Ø	Catalog No.
	Ball Attachment Replica	16.6	4.0	RS5740

	Description	L	Ø	D2	Catalog No.
	Plastic Ball Cap White (Nylon)	2.6	4.1	3.6	RS2660
	Plastic Ball Cap Pink Soft (Nylon)	2.6	4.1	3.6	RS2662
	Titanium Ball Cap	2.9	4.7	4.7	RS2670
	Stainless Steel Ball Cap	2.90	4.70	4.70	RS2675SS

# Grip™ - Overdenture Attachment

As an addition to our wide variety of prosthetic solutions.

Implant supported overdentures are among the most practical prosthetic solutions for patients who cannot utilize fixed restorations, or as an interim solution for patients who are waiting for the osseointegration process of their newly placed implants.

The Grip™ attachment system is a versatile solution, designed to ensure maximum denture retention and stability both for maxillary and mandibular dentures. The variety of retentive caps allow dentists to choose the required retention level needed for each individual case and can easily be replaced, when needed.

The Grip™ attachment system is available for Internal Hex in a range of gingival heights, to enable a reliable, long lasting and cost-effective solution for your patients.

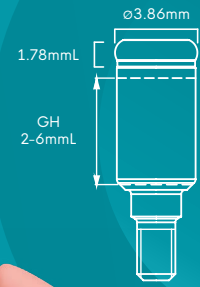

## NP Grip™ Abutments

	Description	Catalog No.
	Grip NP Abutment 1mm	NP0051
	Grip NP Abutment 2mm	NP0052
	Grip NP Abutment 3mm	NP0053
	Grip NP Abutment 4mm	NP0054
	Grip NP Abutment 5mm	NP0055
	Grip NP Abutment 6mm	NP0056

	Description	Catalog No.
	Grip™ for TMA	TM0100
	Grip™ for Bar, M2 thread	RS0101

## Included in Sales Pack

### Grip™ Processing Set

	Description		Description	Catalog No.
	Housing		Light	RS6426
	Processing		Regular	
	Extra Light		Block Out Spacer	







Or



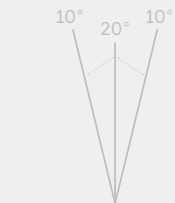

### Grip™ Extended Range processing set

	Description		Description	Catalog No.
	Housing		Light	RS6427
	Processing		Regular	
	Zero		Block Out Spacer	
	Extra Light			

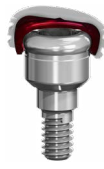
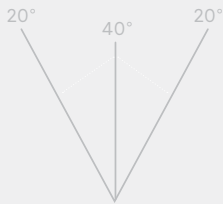

## Grip™ Retention Caps

Grip Retention 4 Pack		Description	Catalog No.
		 Extra Light	RS6417
		 Light	RS6418
		 Regular	RS6419

Grip™ Extended Range Retention 4 Pack		Description	Catalog No.
		 Zero	RS6420
		 Extra Light	RS6421
		 Light	RS6422
		 Regular	RS6423



## Grip™ Accosories

Description	Catalog No.	Description	Catalog No.
 <p>Grip™ Impression Coping 4 Pack Includes RS6415 Grip™ Processing 4 Pack</p>	RS6414	 <p>Grip™ Replica 4 Pack</p>	RS2508
 <p>Metal Housing 4 Pack Includes RS6415 Grip™ Processing 4 Pack</p>	RS6413		 <p>Grip™ Processing 4 Pack</p>
 <p>Grip™ Block Out Spacer 4 Pack</p>	RS6424	 <p>Grip™ Processing 20 Pack</p>	RS6416

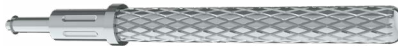
## Grip™ Tools

Description	Description	Catalog No.
	Grip™ core tool	RS6200

Designed for inserting and removing the Grip™ retention males from the metal housing

Description	Catalog No.	Description	Catalog No.	Description	Catalog No.
 <p>Star Hand Driver Short</p>	RP0064	 <p>1.27 Hex torque driver-long</p>	RS6082	 <p>1.27 Hex driver for handpiece - long</p>	RS9035
 <p>Star Hand Driver Long</p>	RP0004	 <p>1.27 Hex torque driver-short</p>	RS6080	 <p>1.27 Hex driver for handpiece - short</p>	RS9030

# Surgical Kits

Successful surgical procedures start with having the right instruments and tools to ensure your desired treatment outcomes are met.

That's why our range has everything you need, including drills, keys, ratchets and insertion tools.

Not only do they make procedures safer and simpler, they result in an enhanced patient experience as well.

Our Surgical Kits streamline and simplify your implant procedures.



# Premium Kit CF6300

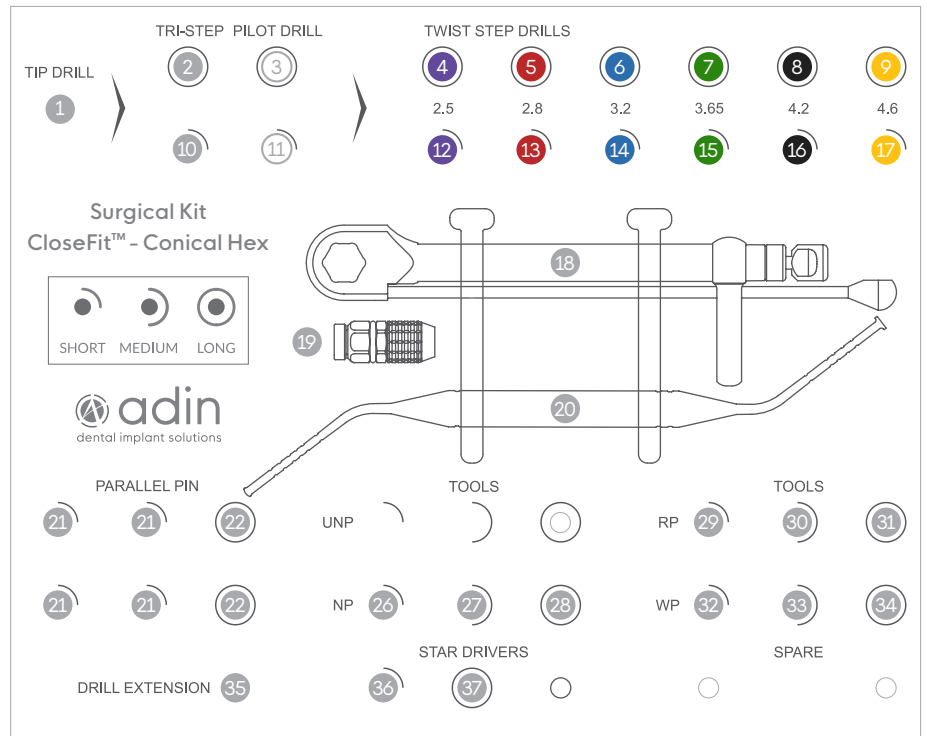

		Drills	Catalog No.
1		Tip Drill	RS8032
2		Tri-Step Drill - Long	TD2218
3		Pilot Drill 2mmD x 8-18mmL	DL1820
4		Twist Step Drill 1.8/2.5mmD x 8-18mmL	DL1825
5		Twist Step Drill 2.3/2.8mmD x 8-18mmL	DL1828
6		Twist Step Drill 2.8/3.2mmD x 8-18mmL	DL1832
7		Twist Step Drill 3.2/3.6mmD x 8-18mmL	DL1836
8		Twist Step Drill 3.8/4.2mmD x 8-18mmL	DL1842
9		Twist Step Drill 4.2/4.6mmD x 8-18mmL	DL1846
10		Tri-Step Drill - Short	TD1511
11		Pilot Drill 2mmD x 6-13mmL	DL1320
12		Twist Step Drill 1.8/2.5mmD x 6-13mmL	DL1325
13		Twist Step Drill 2.3/2.8mmD x 6-13mmL	DL1328
14		Twist Step Drill 2.8/3.2mmD x 6-13mmL	DL1332
15		Twist Step Drill 3.2/3.6mmD x 6-13mmL	DL1336
16		Twist Step Drill 3.8/4.2mmD x 6-13mmL	DL1342
17		Twist Step Drill 4.2/4.6mmD x 6-13mmL	DL1346

		Surgical Tools	Catalog No.
18		Surgical Torque Ratchet 35-100 Ncm	RS6111
19		Wrench Ratchet Surgical Instruments Handle	RA0050
20		Depth Probe	RS6180

		Parallel Pins	Catalog No.
21		Parallel Pin Short 11mm (qty. 4)	RS6150
22		Parallel Pin Short 16mm (qty. 2)	RS6155

		Insertion Tools	Catalog No.
26		NP 2mm Hex Handpiece Adapter - Short	NP0068
27		NP 2mm Hex Handpiece Adapter - Medium	NP0071
28		NP 2mm Hex Handpiece Adapter - Long	NP0074
29		RP 2.25mm Hex Handpiece Adapter - Short	RP0068
30		RP 2.25mm Hex Handpiece Adapter - Medium	RP0071
31		RP 2.25mm Hex Handpiece Adapter - Long	RP0074
32		WP 2.65mm Hex Handpiece Adapter - Short	WP0068
33		WP 2.65mm Hex Handpiece Adapter - Medium	WP0071
34		WP 2.65mm Hex Handpiece Adapter - Long	WP0074

		Drill Extension	Catalog No.
35		Drill Extension	RS9027

		Hex Drivers	Catalog No.
36		Star Hand Driver - Short	RP0064
37		Star Hand Driver - Long	RP0004

\*Products may be ordered separately as an addition to the kit

# Advanced Kit CF6302

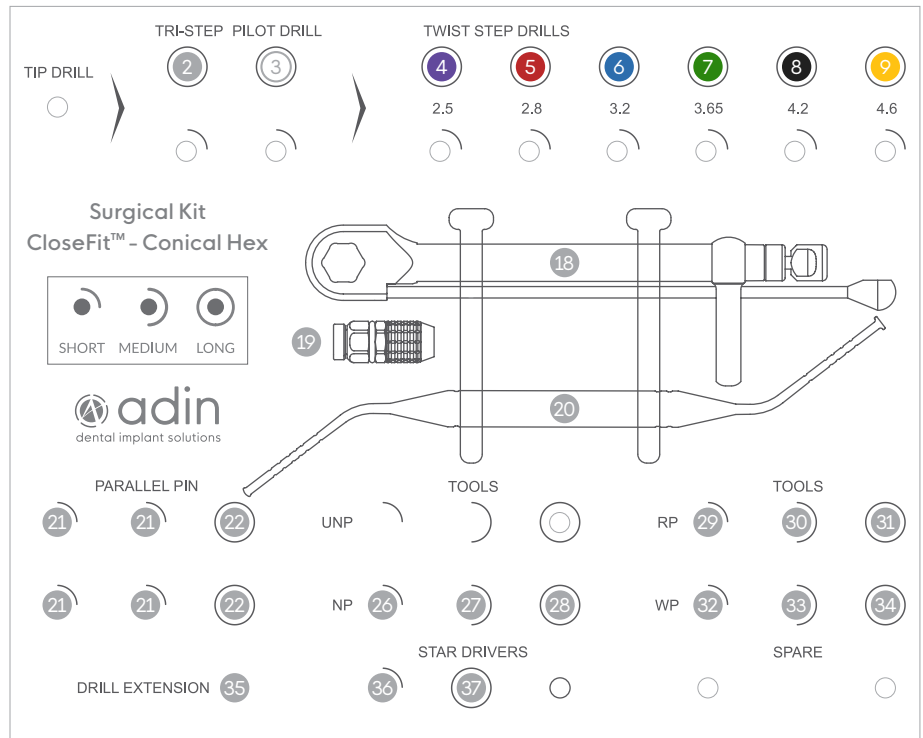

		Drills	Catalog No.
3		Pilot Drill 2mmD x 8-18mmL	DL1820
4		Twist Step Drill 2.3/2.8mmD x 8-18mmL	DL1828
5		Twist Step Drill 2.8/3.2mmD x 8-18mmL	DL1832
6		Twist Step Drill 3.2/3.6mmD x 8-18mmL	DL1836
7		Twist Step Drill 3.8/4.2mmD x 8-18mmL	DL1842
8		Twist Step Drill 4.2/4.6mmD x 8-18mmL	DL1846

		Surgical Tools	Catalog No.
18		Surgical Torque Ratchet 35-100 Ncm	RS6111
19		Wrench Ratchet Surgical Instruments Handle	RA0050
20		Depth Probe	RS6180

		Parallel Pins	Catalog No.
21		Parallel Pin Short 11mm (qty. 4)	RS6150
22		Parallel Pin Short 16mm (qty. 2)	RS6155

		Insertion Tools	Catalog No.
26		NP 2mm Hex Handpiece Adapter - Short	NP0068
27		NP 2mm Hex Handpiece Adapter - Medium	NP0071
28		NP 2mm Hex Handpiece Adapter - Long	NP0074
29		RP 2.25mm Hex Handpiece Adapter - Short	RP0068
30		RP 2.25mm Hex Handpiece Adapter - Medium	RP0071
31		RP 2.25mm Hex Handpiece Adapter - Long	RP0074
32		WP 2.65mm Hex Handpiece Adapter - Short	WP0068
33		WP 2.65mm Hex Handpiece Adapter - Medium	WP0071
34		WP 2.65mm Hex Handpiece Adapter - Long	WP0074

		Drill Extension	Catalog No.
35		Drill Extension	RS9027

		Hex Drivers	Catalog No.
36		Star Hand Driver - Short	RP0064
37		Star Hand Driver - Long	RP0004

\*The advanced kit is also available with short drills | Catalog No. CF6304

# Starter Kit CF6303

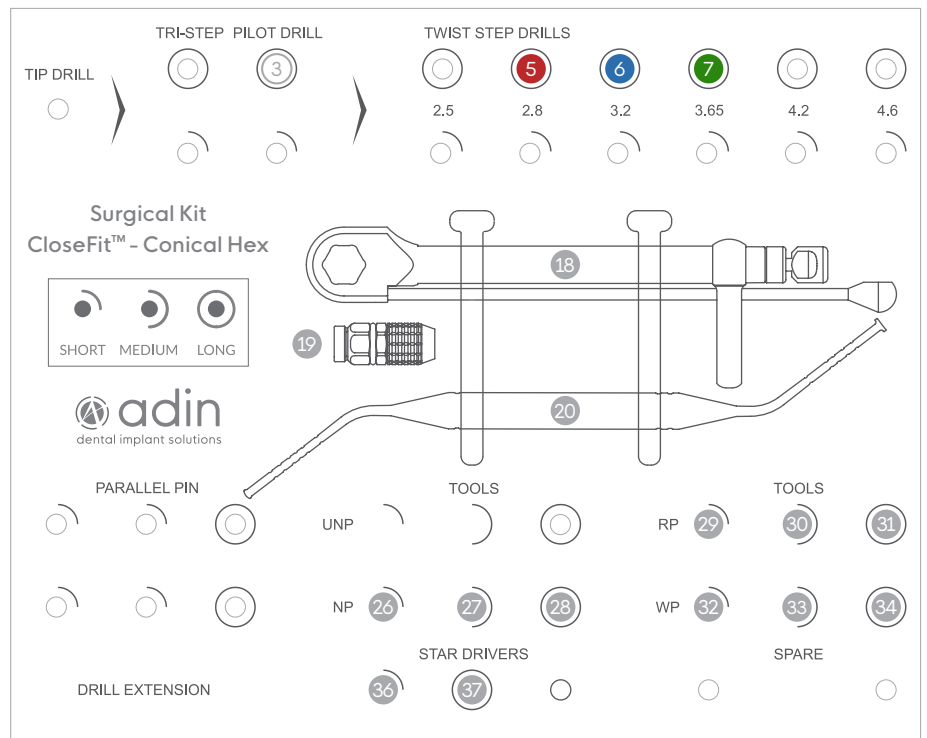

		Drills	Catalog No.
3		Pilot Drill 2mmD x 8-18mmL	DL1820
4		Twist Step Drill 2.3/2.8mmD x 8-18mmL	DL1828
5		Twist Step Drill 2.8/3.2mmD x 8-18mmL	DL1832
6		Twist Step Drill 3.2/3.6mmD x 8-18mmL	DL1836
7		Twist Step Drill 3.8/4.2mmD x 8-18mmL	DL1842

		Insertion Tools	Catalog No.
26		NP 2mm Hex Handpiece Adapter - Short	NP0068
27		NP 2mm Hex Handpiece Adapter - Medium	NP0071
28		NP 2mm Hex Handpiece Adapter - Long	NP0074
29		RP 2.25mm Hex Handpiece Adapter - Short	RP0068
30		RP 2.25mm Hex Handpiece Adapter - Medium	RP0071
31		RP 2.25mm Hex Handpiece Adapter - Long	RP0074
32		WP 2.65mm Hex Handpiece Adapter - Short	WP0068
33		WP 2.65mm Hex Handpiece Adapter - Medium	WP0071
34		WP 2.65mm Hex Handpiece Adapter - Long	WP0074

		Surgical Tools	Catalog No.
20		Wrench Ratchet	RS6100
21		Wrench Ratchet Surgical Instruments Handle	RA0050

		Hex Drivers	Catalog No.
36		Star Hand Driver - Short	RP0064
37		Star Hand Driver - Long	RP0004

# Drills and Tools

Our DLC (Diamond Like Carbon) Tri-Step/Twist Step Surgical Drills are uniquely designed and coated to improve the surgical drilling process.

Tri-Step & Twist-Step DLC drills simplify the cutting process, save time and minimize risks.

Our improved DLC drill coating provides state-of-the-art hardness and slickness that increases lifespan of the drill, maintains sharpness for extended drilling and generates less heat, thereby reducing chances of heating the bone or complications arising from conventional drilling protocols.

The drills come in the following diameters (mm): 2.0, 2.5, 2.8, 3.2, 3.6, 4.2, 4.6, 5.2, 5.6

Specially designed for Adin's implants and suitable for their simple and convenient drilling protocol.

They are clearly and conveniently marked and can be used with or without drill stops.



## Tri-Step Drills









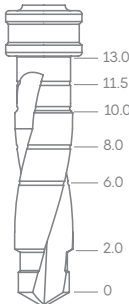

Adin's Tri-Step drills condense drilling protocols and avoid the need for using multiple drills throughout complex procedures.

Because friction at the cutting site is reduced, complications common with high speed drilling are decreased and faster & better recovery can occur.









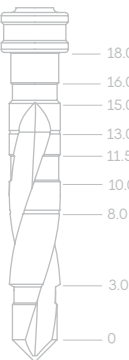

L		Ø	Size	Catalog No.
		1.8-3.2	Short	TD1511
		1.8-3.2	Long	TD2218

# Twist Step Drills

## Short 6-13mm





L		∅	Color	Catalog No.
		2.0	White	DL1320
		1.8-2.5	Purple	DL1325
		2.3-2.8	Red	DL1328
		2.8-3.2	Blue	DL1332
		3.2-3.6	Green	DL1336
		3.9	Pink	DL1339
		3.8-4.2	Black	DL1342
		4.2-4.6	Yellow	DL1346
		4.8-5.2	Brown	DL1352
		5.2-5.6	Grey	DL1356

## Long 8-18mm













L		∅	Color	Catalog No.
		2.0	White	DL1820
		1.8-2.5	Purple	DL1825
		2.3-2.8	Red	DL1828
		2.8-3.2	Blue	DL1832
		3.2-3.6	Green	DL1836
		3.9	Pink	DL1839
		3.8-4.2	Black	DL1842
		4.2-4.6	Yellow	DL1846
		4.8-5.2	Brown	DL1852
		5.2-5.6	Grey	DL1856

# Surgical Tools















	Description	Catalog No.
	Surgical Torque Ratchet 35-100 Ncm	RS6111
	Prosthetic Torque Ratchet 15-35 Ncm	RS6112
	Wrench Ratchet	RS6100
	Surgical Driver	RS7001
	Depth Probe	RS6180



# Hand & Torque Drivers Recommended Torque 25(Ncm)

	Description	Catalog No.
	Star Hand Driver 23.4mm *For Angled TMA/TMA prosthetic screw	RP0064
	Star Hand Driver 23.4mm *For Angled TMA/TMA prosthetic screw	RP0004
	TMA/FC Female Hand Hex Driver 22.4mm *For straight TMA/Flat connection	RS6193
	TMA/FC Female Hand Hex Driver 28.4mm *For straight TMA/Flat connection	RS6191
	Wrench Ratchet Surgical Instruments Handle 16.7mm	RA0050
	UNP/NP Abutment insertion tool 25.9mm	UNP1001
	NP 2mm Hex Torque Driver 17mm	NP0006
	NP 2mm Hex Torque Driver 27mm	NP0005
	Star Torque Driver 20.4mm *For Angled TMA/TMA prosthetic screw	RP0065
	Star Torque Driver 25.4mm *For Angled TMA/TMA prosthetic screw	RP0005
	Torque Driver for Ball Attachment 24.4mm	RS6090
	TMA/FC Hex Torque Driver 20mm *For straight TMA/Flat connection	RS6197
	TMA/FC Hex Torque Driver 25mm *For straight TMA/Flat connection	RS6196





## Handpiece Drivers Recommended Torque 35(Ncm)

	Description	Catalog No.
	NP 2mm Hex Handpiece Adapter 23.7mm	NP0068
	NP 2mm Hex Handpiece Adapter 27.7mm	NP0071
	NP 2mm Hex Handpiece Adapter 36mm	NP0074
	NP 2mm Hex Handpiece Adapter 20mm	NP0062
	NP 2mm Hex Handpiece Adapter 25mm	NP0072
	UNP 2mm Hex Handpiece Adapter Short 23.60L	UNP0068
	UNP 2mm Hex Handpiece Adapter Medium 27.20L	UNP0071
	UNP 2mm Hex Handpiece Adapter Long 36.00L	UNP0074
	Star Handpiece Driver 25mm *For Angled TMA/TMA prosthetic screw	RP0018
	Star Handpiece Drive 30mm *For Angled TMA/TMA prosthetic screw	RP0019
	TMA/FC Hex Handpiece Adapter 20mm *For straight TMA/Flat connection	RS6194
	TMA/FC Hex Handpiece Adapter 25mm *For straight TMA/Flat connection	RS6195A

## Tools

	Description	Catalog No.
	Parallel Pin 11mm	RS6150
	Parallel Pin 16mm	RS6155
	Drill Extension	RS9027

## Osteotomes

	Description	Catalog No.
	Osteotome Handle	HA0074
	Osteotome Insert 2.0mmD	HA0061
	Osteotome Insert 2.8mmD	HA0064
	Osteotome Insert 3.25mmD	HA0067
	Osteotome Insert 3.65mmD	HA0070

# Guided Surgery

The adinguide™ was created with you in mind, bringing the guided surgery world to your clinic.

The kits were specifically designed to support effortless procedures, accurate and predictable implant placement.

The ActiveFlow™ Irrigation Technology is a unique design that forces coolant through the guide to ensure irrigation reaches the bone and prevents overheating.

The adinguide™ drills are designed with carved channels which allow saline coolant from your hand-piece to stream through the sleeve directly into the osteotomy site while drilling.

Our uniquely designed drill kit is intuitive and easy to use by implant diameter and length.

The Tissue Punch and Pilot Drill allow for easy flapless access.

Keyless procedure enables easy handling and full visibility of surgical field.

**Self-centering drills-** controlled by a 5.5mm diameter cylinder at the top of each drill centers the drill in the guide's sleeve.

**Self-centering cylinder** engages the sleeve before the drill engages the osteotomy in order to ensure correct positioning of the drill.

**Built-in stoppers-** ensure precise and accurate drilling to the desired depth.



# Guided Surgery Kit

## CloseFit™ UNP/NP Narrow Implants Drills & Tools

### GSK002

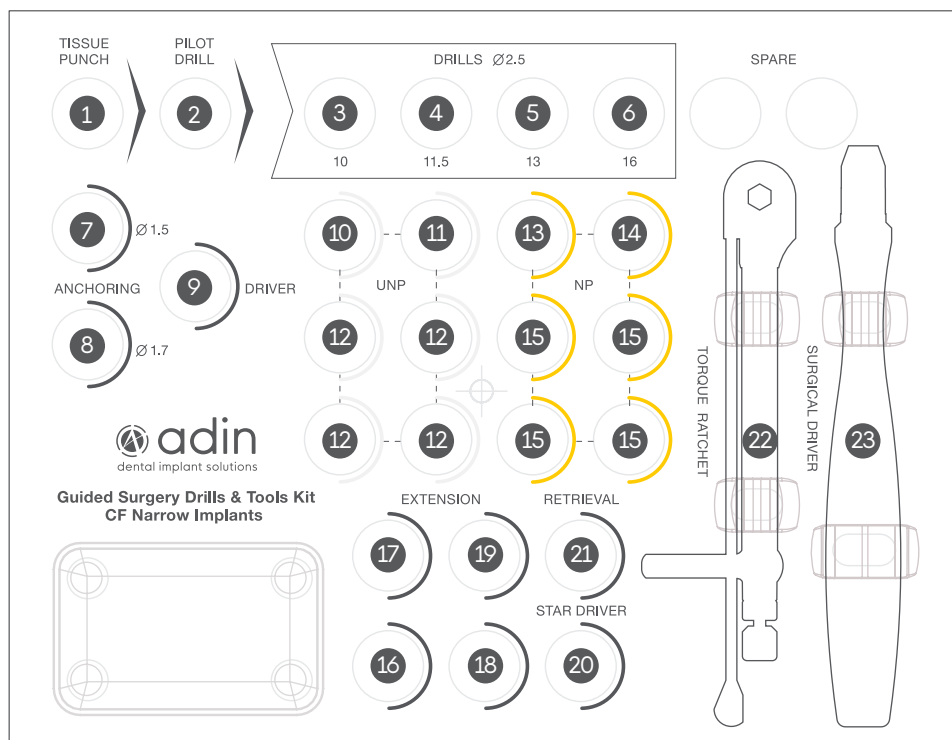













For full  
guided  
procedure:













CloseFit™ UNP/NP  
Narrow Implant Platform





Narrow Implants 3.3mmD Sleeve  
GS0033

	Description	Catalog No.
1	 NØ3.0 Narrow Tissue Punch 3.0mmD, S-3.3	GSN3033
2	 6 NØ2.5 L6 Pilot Drill S-3.3, 2.5/1.8mmDx6.0mmL	GSN0625
3	 NØ2.5 L10 Drill S-3.3, 2.5/1.8mmDx10.0mmL	GSN1025
4	 NØ2.5 L11.5 Drill S-3.3, 2.5/1.8mmDx11.5mmL	GSN1125
5	 NØ2.5 L13 Drill S-3.3, 2.5/1.8mmDx13.0mmL	GSN1325
6	 NØ2.5 L16 Drill S-3.3, 2.5/1.8mmDx16.0mmL	GSN1625
7	 Ø1.5 L19 Anchoring Drill S-2.0, 2.0/1.5mmDx19mmL	GS1915
8	 Ø1.7 L19 Anchoring Drill S-2.0, 2.0/1.7mmDx19mmL	GS1917
9	 Handpiece Guide Fixation Screw Driver	GS0028
10	 Guided UNP Handpiece Fixture Mount S-3.3	GS0018
11	 Guided UNP Ratchet Fixture Mount S-3.3	GS0016
12	 Guided UNP Ratchet Fixture Mount S-3.3, Screw Retained	GS0014





	Description	Catalog No.
13	 Guided NP Handpiece Fixture Mount S-3.3	GS0017
14	 Guided NP Ratchet Fixture Mount S-3.3	GS0019
15	 Guided NP Ratchet Fixture Mount S-3.3, Screw Retained	GS0013
16	 Manual Socket L10.5	GS0023
17	 Manual Socket L14.5	GS0024
18	 Handpiece Socket L10.5	GS0021
19	 Drill extension	RS9027
20	 Star Hand Driver - Long	RP0004
21	 NP&UNP Ratchet retrieval tool	GS0045
22	 adin Surgical Torque Ratchet 35-100 Ncm for hex 4mm	GS6111
23	 Guide Fixation Screw Driver	GS0027



### 18mm Drills

	Description	Catalog No.
	Drill S-5.5, 2.5/1.8mmDx18.0mmL	GS1825
	Drill S-3.3, 2.5/1.8mmDx18.0mmL	GSN1825

### Accessories

	Description	Purchase Options	Catalog No.
	Guided Vertical Fixation Screw S-3.3	x3 pack	GS0006
	2.0mmD Anchoring Screw	x3 pack	GS1920
	2.0mmD Anchoring Sleeve	x3 pack	GS0020
	3.3mmD Narrow Implants Sleeve	x1 pack	GS0033
		x3 pack	GS0033x3
		x10 pack	GS0033x10

\* Illustrations are not to scale

\* Availability of the products in some places is limited and depends on local regulations.

\* For more information, please contact your local representative.





CloseFit™

# Regular and Wide Implants

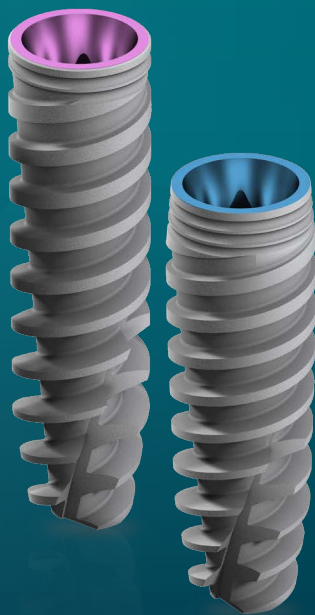

CloseFit™

# Regular and Wide Implants

Our strong CloseFit™ Conical Connection is designed for optimal seating while reducing and virtually eliminating micromovements. Appropriate for immediate function/loading capability in all bone types.

CloseFit™ implants are designed to be used in all indications and in all regions of the lower and upper jaws.

The back-tapered coronal portion is designed to reduce pressure and enable healthy cortical bone around the implant collar

## CloseFit™ RP

Ø 3.5mmD

Regular Platform

\* Built-In Platform Switching

\* Minimally invasive surgery

\* Osseofix™

\* Length

L-8mm | L-10 mm | L-11.5 mm

L-13 mm | L-16 mm | L-18 mm

## CloseFit™ WP

Ø 4.3/5.0mmD

Wide Platform

\* Back tapered collar

\* Micro Threads: Engineered to enhance bone regeneration, prevent bone loss & increase bone implant contact

\* Bone - condensing property

\* Self - drilling

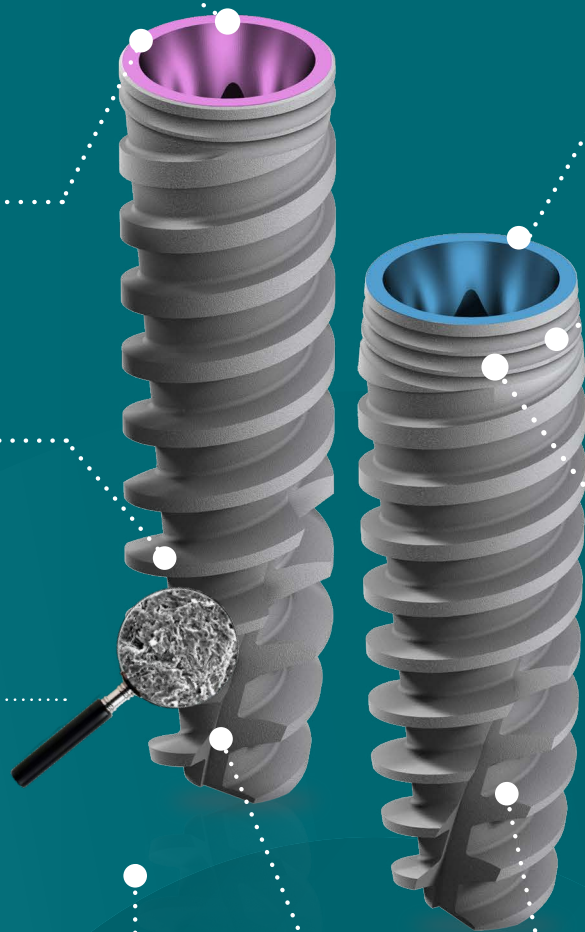

\*The features related to WP & RP Implants

# RP CloseFit™ Regular Platform

Recommended insertion torque up to 50 Ncm

	D1	L	D2	Catalog No.
	3.5	8.0	1.5	ISPX0835
		10.0	1.5	ISPX1035
		11.5	1.5	ISPX1135
		13.0	1.5	ISPX1335
		15.0	1.5	ISPX1535
		18.0	1.5	ISPX1835

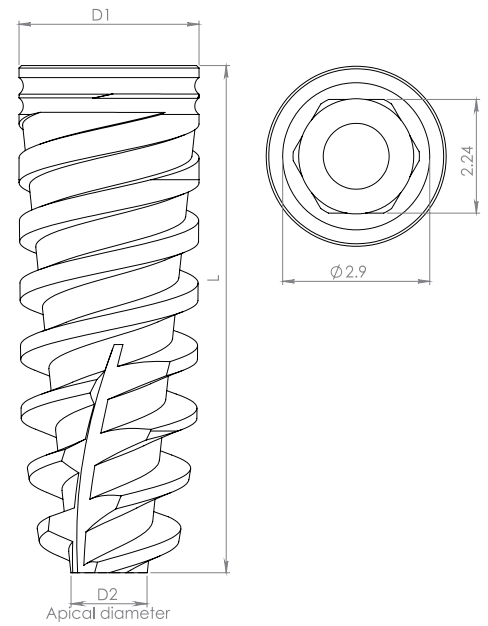

Radiographic Template RP CloseFit™ | ASD0612

## Drill Sequence for RP Recommended drilling speed up to 1200 rpm

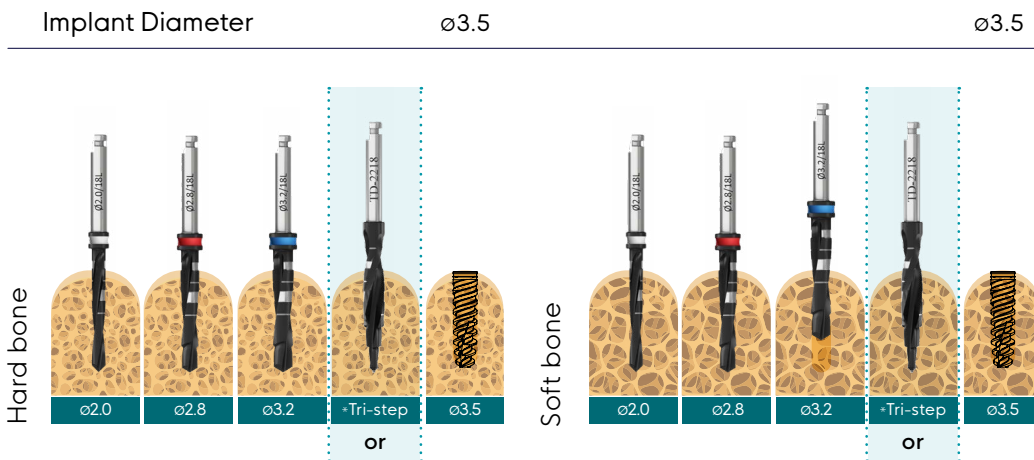

All measurements are in mm

\*Products may be ordered separately as an addition to the kit.

Note: (x.xx) Drill to the depth of the cortex only. All measurements are in mm.

⚠ CAUTION: The drill preparation is up to 1mm longer than the implant.

\* The drill apical step = 1.8mmD.

# WP CloseFit™ Wide Platform

Recommended insertion torque up to 50 Ncm

	D1	L	D2	Catalog No.
	4.3	8.0	1.9	ISPX0843
		10.0	1.9	ISPX1043
		11.5	1.9	ISPX1143
		13.0	1.9	ISPX1343
		15.0	1.9	ISPX1543
		18.0	1.9	ISPX1843
	5	8.0	2.5	ISPX0849
		10.0	2.5	ISPX1049
		11.5	2.5	ISPX1149
		13.0	2.5	ISPX1349
		15.0	2.5	ISPX1549
		18.0	2.5	ISPX1849

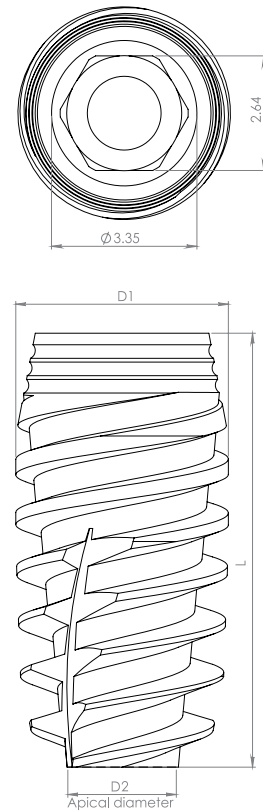

Radiographic Template WP CloseFit™ | ASD0611

## Drill Sequence for RP Recommended drilling speed up to 1200 rpm

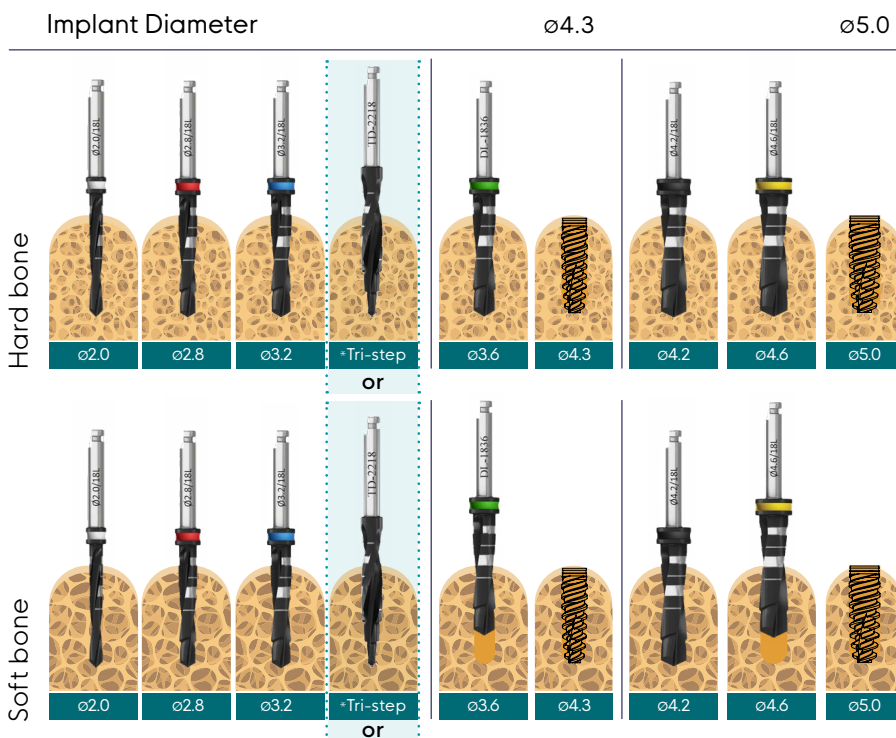

All measurements are in mm

\*Products may be ordered separately as an addition to the kit.

Note: (x.xx) Drill to the depth of the cortex only. All measurements are in mm.

⚠ CAUTION: The drill preparation is up to 1mm longer than the implant.





\* The drill apical step = 1.8mmD.

# Cover Screw & Healing Abutments



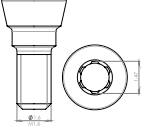

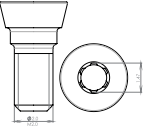





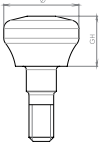

Recommended Torque 15(Ncm)

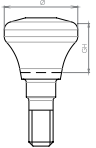

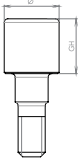
## Cover Screw Packed with implant

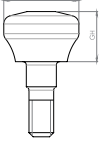
		Description	Catalog No.
		RP CloseFit™ Conical Cover Screw	RP0073
		WP CloseFit™ Conical Cover Screw	WP0073

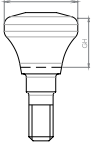
## Healing Abutments

		Description	∅	GH	Catalog No.
		RP CloseFit™ Slim Healing Abutment	3.5	2	RP0046
			3.5	3	RP0047
			3.5	4	RP0048
			3.5	5	RP0049
			3.5	6	RP0050
		RP CloseFit™ Healing Abutment	4.5	2	RP0022
			4.5	3	RP0023
			4.5	4	RP0024
			4.5	5	RP0025
			4.5	6	RP0026
		RP CloseFit™ Conical Healing Abutment	4.5	2	RP0090
			4.5	3	RP0091
			4.5	4	RP0092
			4.5	5	RP0093
			4.5	6	RP0094
		WP CloseFit™ Slim Healing Abutment	4.0	2	WP0046
			4.0	3	WP0047
			4.0	4	WP0048
			4.0	5	WP0049
			4.0	6	WP0050
		WP CloseFit™ Healing Abutment	5.5	2	WP0022
			5.5	3	WP0023
			5.5	4	WP0024
			5.5	5	WP0025
			5.5	6	WP0026
		WP CloseFit™ Conical Healing Abutment	5.5	2	WP0090
			5.5	3	WP0091
			5.5	4	WP0092
			5.5	5	WP0093
			5.5	6	WP0094

# Impression Recommended Torque 15(Ncm)

Our components for taking impressions for all restoration types can be successfully utilized for digital or conventional protocols either implant-level or abutment level procedures.

Our broad range of solutions and flexible designs enable easy and accurate restorative planning, whether you're dealing with a single tooth, multiple teeth, bridge or full mouth rehabilitation.



## RP Transfers | Recommended Torque 15(Ncm)

	Open Tray	Description	L	D1	H	Catalog No.		Close Tray	Description	L	D1	H	Catalog No.
		RP Open Tray Transfer Short	19.5	6.0	11.8	RP5613			RP Close Tray Transfer Short	10.7	3.6	8.8	RP5111
		RP Open Tray Transfer Long	23.5	6.0	14.8	RP5617			RP Close Tray Transfer Long	14.9	3.6	13.0	RP5115

## WP Transfers | Recommended Torque 15(Ncm)

	Open Tray	Description	L	D1	H	Catalog No.		Close Tray	Description	L	D1	H	Catalog No.
		WP Open Tray Transfer Short	19.5	6.0	11.8	WP5613			WP Close Tray Transfer Short	10.7	3.6	8.8	WP5111
		WP Open Tray Transfer Long	23.5	6.0	14.8	WP5617			WP Close Tray Transfer Long	15.0	3.6	13.0	WP5115

## RP Scan Bodies

	Description	H	Catalog No.		Description	H	Catalog No.
	RP Scan Body	7	RP0088		RP Scan Body	10	RP0089

## WP Scan Bodies

	Description	H	Catalog No.		Description	H	Catalog No.
	WP Scan Body	7	WP0088		WP Scan Body	10	WP0089

## RP Analogs

	Description	L	D1	Catalog No.		Description	Catalog No.		Description	L	D1	Catalog No.
	RP Digital Analog 15(Ncm)	10.0	3.55	RP1000		Retaining Screw	RS1002		RP Implant Analog	12.6	3.55	RP0007

## WP Analogs

	Description	L	D1	Catalog No.		Description	Catalog No.		Description	L	D1	Catalog No.
	WP Digital Analog 15(Ncm)	10.0	4.0	WP1000		Retaining Screw	RS1002		WP Implant Analog	13.0	4.0	WP0007

## Temporary & Cement Retained Restoration



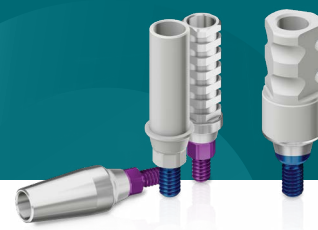

Recommended Torque 35(Ncm)



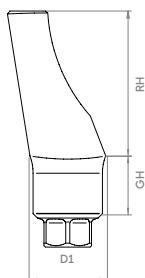

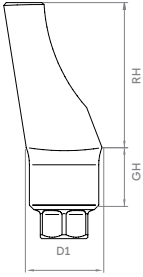



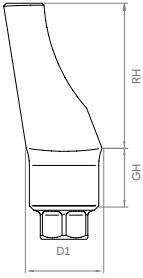

## RP Abutments

	Description	D1	GH	RH	Catalog No.
	RP Engaging Temporary Abutment	3.7	1.0	9.45	RP0043
	RP Non-Engaging Temporary Abutment	3.7	1.0	9.45	RP0044
	RP Straight Slim Abutment No End Line	4.0	2.8	6.0	RP0020
	RP Esthetic Straight Abutment	4.4	1.0	6.5	RP0012
		4.4	2.0	6.5	RP0011
		4.4	3.0	6.5	RP0010
	RP Esthetic Angled Abutment 15°	4.4	1.0	6.5	RP0013
		4.4	2.0	6.5	RP0014
		4.4	3.0	6.5	RP0015
	RP Angled Titanium Abutment 25°	4.5	1.0	6.1	RP0251
		4.5	2.0	6.1	RP0252
		4.5	3.0	6.1	RP0253
	RP Angled Titanium Abutment 35°	4.5	1.0	6.1	RP0351
		4.5	2.0	6.1	RP0352
		4.5	3.0	6.1	RP0353



		Description	D1	GH	RH	Catalog No.
		RP Engaging Plastic Cylinder Abutment (Casting)	3.7	1.0	9.5	RP0045
		RP Engaging Cobalt Chrome/Plastic Abutment	4.7	1.5	10.0	RP3094
		RP Engaging Titanium/Plastic Abutment (Casting)	4.7	1.5	10.0	RP3095
		RP Non-Engaging Titanium/Plastic Abutment (Casting)	4.7	1.36	10.0	RP3097
		RP Non-Engaging Cobalt Chrome/Plastic Abutment	4.7	1.36	10.0	RP3100

## WP Abutments

		Description	D1	GH	RH	Catalog No.
		WP Engaging Temporary Abutment	4.2	0.9	9.45	WP0043
		WP Non-Engaging Temporary Abutment	4.2	0.9	9.45	WP0044
		WP Straight Slim Abutment No End Line	4.2	2.7	6.0	WP0020
		WP Straight Abutment	5.0	1.0	6.5	WP0012
			5.0	2.0	6.5	WP0011
			5.0	3.0	6.5	WP0010
		WP Angled Abutment 15°	5.0	1.0	6.5	WP0013
			5.0	2.0	6.5	WP0014
			5.0	3.0	6.5	WP0015
		WP Angled Titanium Abutment 25°	5.0	1.0	6.0	WP0251
			5.0	2.0	6.0	WP0252
			5.0	3.0	6.0	WP0253
		WP Angled Titanium Abutment 35°	5.0	1.0	6.0	WP0351
			5.0	2.0	6.0	WP0352
			5.0	3.0	6.0	WP0353
	WP Plastic Cylinder Abutment (Casting)	4.2	0.9	9.45	WP0045	
	WP Engaging Titanium/Plastic Abutment (Casting)	5.2	1.5	10.0	WP3095	
	WP Non-Engaging Titanium/Plastic Abutment (Casting)	5.2	1.5	10.0	WP3097	

# Iris™ Snap - on for RP and WP

Adin's Snap-on impression is an effective and easy option for both implant level and abutment level impression copying. Plastic pickup cap placed over a precision machined abutment allows for accurate coping utilizing closed tray impression. Adin's Snap-on range aims to allow flexibility by offering various options to match users preferred method of use through pre packed kits:

- IRIS™ Kit - abutment level impression and restoration set
- Snap-on impression kit - implant level impression

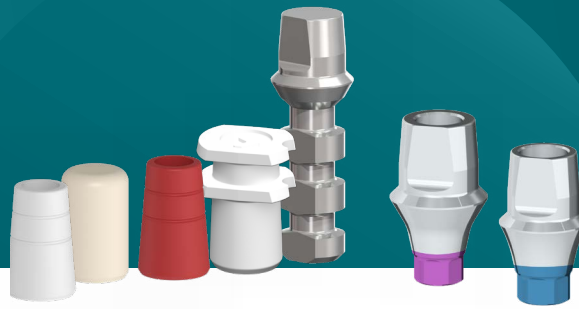

## RP Iris™ Kit



Description	RH	GH	Catalog No.
Iris™ RP CloseFit™ Kit	4	1	IR3041
		2	IR3042
		3	IR3043
		4	IR3044
	6	1	IR3061
		2	IR3062
		3	IR3063
		4	IR3064
	8	1	IR3081
		2	IR3082
		3	IR3083
		4	IR3084

## RP Snap-on Impression Kit



Description	RH	GH	Catalog No.
Iris™ RP Snap-on Impression Kit	4	1	IR3141
		2	IR3142
		3	IR3143
		4	IR3144
	6	2	IR3262
		4	IR3264

## RP Snap-on Impression Pack



Description	RH	GH	Catalog No.
Iris™ RP Abutment	4	1	IR0341
		2	IR0342
		3	IR0343
		4	IR0344
	6	1	IR0361
		2	IR0362
		3	IR0363
		4	IR0364
	8	1	IR0381
		2	IR0382
		3	IR0383
		4	IR0384

## WP Iris™ Kit



Description	RH	GH	Catalog No.
Iris™ WP CloseFit™ Kit	4	1	IR5041
		2	IR5042
		3	IR5043
		4	IR5044
	6	1	IR5061
		2	IR5062
		3	IR5063
		4	IR5064

## WP Snap-on Impression Kit





Description	RH	GH	Catalog No.
Iris™ WP Snap-on Impression Kit	4	1	IR5141
		2	IR5142
		3	IR5143
		4	IR5144
	6	2	IR5262
		4	IR5264



## WP Snap-on Impression Pack



Description	RH	GH	Catalog No.
Iris™ WP Abutment	4	1	IR0541
		2	IR0542
		3	IR0543
		4	IR0544
	6	1	IR0561
		2	IR0562
		3	IR0563
		4	IR0564

## Purchase Options

	Description	RH	Catalog No.
	RP Implant Analog	-	RP0007
	WP Implant Analog	-	WP0007
	Iris™ Abutment replica	4	IR0404
		6	IR0406
		8	IR0408
	Iris™ PEEK Comfort cap	4	IR0180
		6	IR0181
		8	IR0189







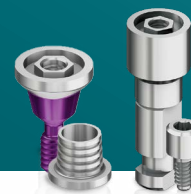





	Description	Qty	Catalog No.
	Iris™, Burnout anti rotation cap red	1	IR0182
		4	IR0185
	Iris™, Burnout cap white	4	IR0183
		6	IR0186
	Iris™, Impression coping	1	IR0179
		4	IR0184

# Screw - Retained













Recommended Torque 35(Ncm)



## RP Screws

	Description	L	∅	Catalog No.
	RP Abutment Screw	7.2	2.2	RP0001
	TMA Prosthetic Screw 15(Ncm)	4.1	2.1	RS3404
	RP Retaining Screw for TMA 1mm	8.0	3.1	RP0039
	RP Retaining Screw for TMA 2mm	9.0	3.1	RP0040
	RP Retaining Screw for TMA 3mm	10.0	3.1	RP0041
	RP Retaining Screw for TMA 4mm	11.0	3.1	RP3409
	RP Retaining Screw for TMA 5mm	12.0	3.1	RP3412
	RP Retaining Screw for Angled TMA	7.0	2.35	RP3403
	RP Open Tray Transfer Screw - Short	24.0	3.1	RP5010
	RP Open Tray Transfer Screw - Long	28.0	3.1	RP5014
	RP Closed Tray Transfer Screw - Short	16.0	2.8	RP5126
	RP Closed Tray Transfer Screw - Long	20.0	2.8	RP5127
	RP Retrieval Screw for Abutments	12.6	2.25	RP3401

## WP Screws





	Description	L	Ø	Catalog No.
	WP Abutment Screw	7.5	2.55	WP0001
	TMA Prosthetic Screw 15(Ncm)	4.1	2.1	RS3404
	WP Retaining Screw for TMA	6.5	3.1	WP3406
	WP Retaining Screw for TMA	7.5	3.1	WP3407
	WP Retaining Screw for TMA	8.5	3.1	WP3408
	WP Retaining Screw for TMA	9.5	3.1	WP3409
	WP Retaining Screw for TMA	10.5	3.1	WP3412
	WP Retaining Screw for Angled TMA	7.1	2.35	WP3403
	WP Open Tray Transfer Screw - Short	24.0	3.1	WP5010
	WP Open Tray Transfer Screw - LONG	28.0	3.1	WP5014
	WP Closed Tray Transfer Screw - Short	16.5	3.1	WP5126
	WP Closed Tray Transfer Screw - Long	20.0	3.1	WP5127
	WP Retrieval Screw for Abutments	12.3	2.55	WP3401

# Single TMA™ Recommended Torque 35(Ncm)



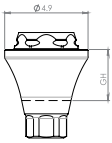

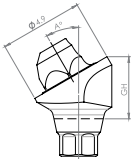
Adding to Adin's variety of the screw-retained restoration range, in comes the single TMA. Utilizing all the benefits of the TMA abutments while allowing the accuracy and flexibility for single tooth restoration.

Adin's STMA offers the possibility to combine the benefits of trans-gingival approach and screw-retained single tooth restoration yielding greater flexibility in both esthetics, safety and restoration maintenance. Adin's Single TMA is based on the TMA abutment, while the added hex index offers both the required accurate positioning and retention to support a single tooth crown. Open and closed tray transfers as well as scan bodies for digital impression are available to match every preferred impression method as well as replicas for straight forward and simple work process.

## RP Abutments

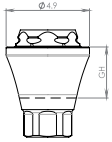
		Description	GH	Catalog No.
		RP Straight Single TMA Abutment 1mm	1.0	RP0032S
		RP Straight Single TMA Abutment 2mm	2.0	RP0033S
		RP Straight Single TMA Abutment 3mm	3.0	RP0034S
		RP Straight Single TMA Abutment 4mm	4.0	RP3729S
		RP Straight Single TMA Abutment 5mm	5.0	RP3730S
		RP Angled Single TMA Abutment 17° 2.5mm	2.6	RP3734S
		RP Angled Single TMA Abutment 30° 3mm	3.7	RP3735S
		RP Angled Single TMA Abutment 17° 3.5mm	3.5	RP3737S
		RP Angled Single TMA Abutment 30° 4mm	4.0	RP3738S

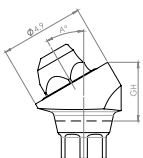

## WP Abutments

		Description	GH	Catalog No.
		WP Straight Single TMA Abutment 1mm	1.0	WP3731S
		WP Straight Single TMA Abutment 2mm	2.0	WP3732S
		WP Straight Single TMA Abutment 3mm	3.0	WP3733S
		WP Straight Single TMA Abutment 4mm	4.0	WP3729S
		WP Straight Single TMA Abutment 5mm	5.0	WP3730S
		WP Angled Single TMA Abutment 17° 2.5mm	2.5	WP3734S
		WP Angled Single TMA Abutment 30° 3mm	3.5	WP3735S
		WP Angled Single TMA Abutment 17° 3.5mm	3.5	WP3737S
		WP Angled Single TMA Abutment 30° 4mm	4.1	WP3738S

## Transfers

	Description	L	D1	D2	Catalog No.		Description	L	D1	D2	Catalog No.
	Single TMA Impression Coping Open Tray	11.0	4.9	3.1	RS5006S		Single TMA Closed Tray Transfer	8.0	4.9	4.1	RS5011S

## Snap-On

	Description	L	D1	D2	Catalog No.		Description	Catalog No.
	Single TMA Snap-On Transfer	8.0	4.9	3.2	RS5012S		IRIS™, Impression coping	IR0179





## Analogs

	Description	L	D1	Catalog No.		Description	L	D1	D2	Catalog No.
	Single TMA Abutment Replica	16.8	3.35	RS5004S		Single TMA Digital Model Replica Recommended torque 15(Ncm)	12.0	4.9	3.8	RS1001S

## Scan Bodies

	Description	L	D1	Catalog No.
	Single TMA Scan Body	6.0	4.9	TM0006S
		9.0	4.9	TM0009S

## STMA Prosthetics

	Description	L	D1	D2	H	Catalog No.
	Single TMA Titanium Temporary	12.0	4.9	3.5	10.5	RS4900S
	Single TMA Plastic Casting Sleeve w/Prosthetic Screw	12.0	4.9	3.3	10.5	RS5001S
	Single TMA Healing Cup	5.5	4.9	3.5	-	RS5005S
	Single TMA Cementing Cone, low profile	4.9	5.5	3.2	-	TM0011S





# CAD CAM

Adin's CAD - CAM components and digital libraries enable clinicians and technicians to design and manufacture state-of-the-art restorations supported by Adin's implants, using current digital restoration processes.



The variety of components ensures endless restorative options for treatment of single, multiple, partially, or fully edentulous cases.







## RP

For Intra-oral and Desktop Scanner		H	Catalog No.	For Medentika PreFace® Holder		Ø	Catalog No.
	RP Scan Body	7	RP0088		RP Ti Blank	11.5	RP1211
		10	RP0089			15.8	RP1215

## WP

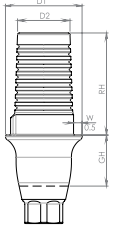

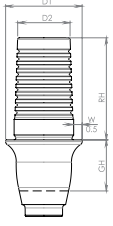

For Intra-oral and Desktop Scanner		H	Catalog No.	For Medentika PreFace® Holder		Ø	Catalog No.
	WP Scan Body	7	WP0088		WP Ti Blank	11.5	WP1311
		10	WP0089			15.8	WP1315

## RP Ti Base Abutments



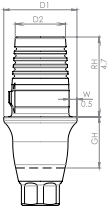

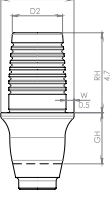
		Description	RH	GH	D1	D2	Catalog No.
		Ti Base RP Abutment, <b>Engaged</b>	4.0	1.0	4.5	3.2	TB03411
		4.0	2.0	4.5	3.2	TB03421	
		4.0	3.0	4.5	3.2	TB03431	
		4.0	4.0	4.5	3.2	TB03441	
		6.0	1.0	4.5	3.1	TB03611	
		6.0	2.0	4.5	3.1	TB03621	
		6.0	3.0	4.5	3.1	TB03631	
		6.0	4.0	4.5	3.1	TB03641	
		8.0	1.0	4.5	2.9	TB03811	
		8.0	2.0	4.5	2.9	TB03821	
		8.0	3.0	4.5	2.9	TB03831	
		8.0	4.0	4.5	2.9	TB03841	
		Ti Base RP Abutment, <b>Non Engaged</b>	4.0	1.0	4.5	3.2	TB03412
		4.0	2.0	4.5	3.2	TB03422	
		4.0	3.0	4.5	3.2	TB03432	
		4.0	4.0	4.5	3.2	TB03442	
		6.0	1.0	4.5	3.1	TB03612	
		6.0	2.0	4.5	3.1	TB03622	
		6.0	3.0	4.5	3.1	TB03632	
		6.0	4.0	4.5	3.1	TB03642	
		8.0	1.0	4.5	2.9	TB03812	
		8.0	2.0	4.5	2.9	TB03822	
		8.0	3.0	4.5	2.9	TB03832	
		8.0	4.0	4.5	2.9	TB03842	



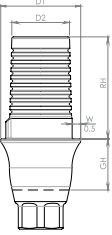

## RP C-Type Ti Base Abutments

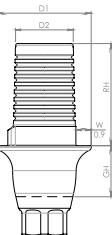
For further product information and use please refer to IFU028

	Description	RH	GH	D1	D2	Catalog No.
	 C-Type Ti Base RP Abutment, <b>Engaged</b>	4.7	1.0	4.3	2.9	TB03414
		4.7	2.0	4.3	2.9	TB03424
		4.7	3.0	4.3	2.9	TB03434
		4.7	4.0	4.3	2.9	TB03444
	 C-Type Ti Base RP Abutment, <b>Non Engaged</b>	4.7	1.0	4.3	2.9	TB03415
		4.7	2.0	4.3	2.9	TB03425
		4.7	3.0	4.3	2.9	TB03435
		4.7	4.0	4.3	2.9	TB03445

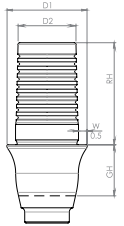

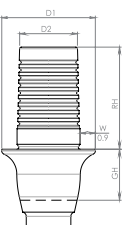



## WP Ti Base Abutments

	Description	RH	GH	D1	D2	Catalog No.
	 Ti Base WP Abutment, <b>Engaged</b>	4.0	1.0	4.7	3.5	TB05411
		4.0	2.0	4.7	3.5	TB05421
		4.0	3.0	4.7	3.5	TB05431
		4.0	4.0	4.7	3.5	TB05441
		6.0	1.0	4.7	3.4	TB05611
		6.0	2.0	4.7	3.4	TB05621
		6.0	3.0	4.7	3.4	TB05631
		6.0	4.0	4.7	3.4	TB05641
		8.0	1.0	4.7	3.3	TB05811
		8.0	2.0	4.7	3.3	TB05821
		8.0	3.0	4.7	3.3	TB05831
		8.0	4.0	4.7	3.3	TB05841
	 Ti Base WP Abutment, <b>Engaged Wide</b>	4.0	1.0	5.5	3.5	TB05411W
		4.0	2.0	5.5	3.5	TB05421W
		4.0	3.0	5.5	3.5	TB05431W
		4.0	4.0	5.5	3.5	TB05441W
		6.0	1.0	5.5	3.4	TB05611W
		6.0	2.0	5.5	3.4	TB05621W
		6.0	3.0	5.5	3.4	TB05631W
		6.0	4.0	5.5	3.4	TB05641W
		8.0	1.0	5.5	3.3	TB05811W
		8.0	2.0	5.5	3.3	TB05821W
		8.0	3.0	5.5	3.3	TB05831W
		8.0	4.0	5.5	3.3	TB05841W

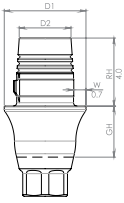
	Description	RH	GH	D1	D2	Catalog No.
	 Ti Base WP Abutment, <b>Non Engaged</b>	4.0	1.0	4.7	3.5	TB05412
		4.0	2.0	4.7	3.5	TB05422
		4.0	3.0	4.7	3.5	TB05432
		4.0		4.7	3.5	TB05442
		6.0	1.0	4.7	3.4	TB05612
		6.0	2.0	4.7	3.4	TB05622
		6.0	3.0	4.7	3.4	TB05632
		6.0	4.0	4.7	3.4	TB05642
		8.0	1.0	4.7	3.3	TB05812
		8.0	2.0	4.7	3.3	TB05822
		8.0	3.0	4.7	3.3	TB05832
		8.0	4.0	4.7	3.3	TB05842
	 Ti Base WP Abutment, <b>Non Engaged Wide</b>	4.0	1.0	5.5	3.5	TB05412W
		4.0	2.0	5.5	3.5	TB05422W
		4.0	3.0	5.5	3.5	TB05432W
		4.0	4.0	5.5	3.5	TB05442W
		6.0	1.0	5.5	3.4	TB05612W
		6.0	2.0	5.5	3.4	TB05622W
		6.0	3.0	5.5	3.4	TB05632W
		6.0	4.0	5.5	3.4	TB05642W
		8.0	1.0	5.5	3.3	TB05812W
		8.0	2.0	5.5	3.3	TB05822W
		8.0	3.0	5.5	3.3	TB05832W
		8.0	4.0	5.5	3.3	TB05842W

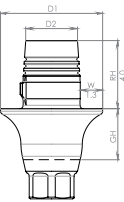
## WP C-Type Ti Base Abutments

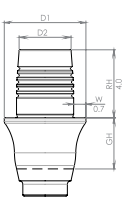
For further product information and use please refer to IFU028

	Description	RH	GH	D1	D2	Catalog No.
	 C-Type Ti Base WP Abutment, <b>Engaged</b>	4.0	1.0	4.8	3.0	TB05414
		4.0	2.0	4.8	3.0	TB05424
		4.0	3.0	4.8	3.0	TB05434
		4.0	4.0	4.8	3.0	TB05444
	 C-Type Ti Base WP Abutment, <b>Engaged Wide</b>	4.0	1.0	6.0	3.0	TB05414W
		4.0	2.0	6.0	3.0	TB05424W
		4.0	3.0	6.0	3.0	TB05434W
		4.0	4.0	6.0	3.0	TB05444W
	 C-Type Ti Base WP Abutment, <b>Non Engaged</b>	4.0	1.0	4.8	3.1	TB05415
		4.0	2.0	4.8	3.1	TB05425
		4.0	3.0	4.8	3.1	TB05435
		4.0	4.0	4.8	3.1	TB05445

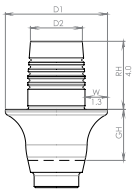
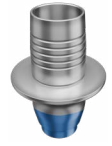
	Description	RH	GH	D1	D2	Catalog No.
	 C-Type Ti Base WP Abutment, <b>Non Engaged Wide</b>	4.0	1.0	6.0	3.1	TB05415W
		4.0	2.0	6.0	3.1	TB05425W
		4.0	3.0	6.0	3.1	TB05435W
		4.0	4.0	6.0	3.1	TB05445W

## CAD CAM | Angulated Screw Channel



The angulated screw channel (ASC) solution offers a transformative approach to dental restorations. ASC strategically places a screw access hole at an angle within the prosthesis, optimizing both function and esthetics.

By integrating digital planning and specialized drivers, ASC enhances accuracy and predictability in implant-supported restorations. This approach signifies a significant advancement in dental care, prioritizing esthetics and functionality to ensure patient satisfaction.

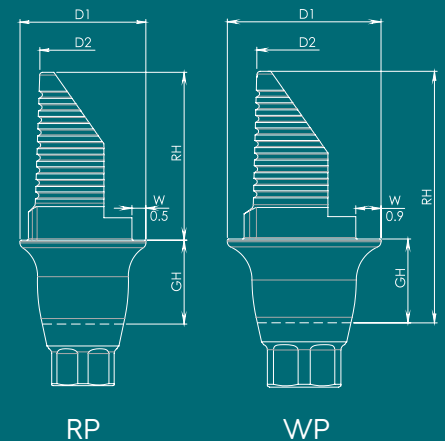

Adin's angulated screw channel Ti bases support gingival heights of 1-3mm for every each implant platform and allow for angulation of up to 20 degrees.



### RP Ti Base Abutment Angular

	RH	GH	D1	D2	Catalog No.
 RP Ti Base Abutment Angular <b>Engaged</b>	4.0	1.0	4.5	3.2	TB03413
	4.0	2.0	4.5	3.2	TB03423
	4.0	3.0	4.5	3.2	TB03433
	6.0	1.0	4.5	3.1	TB03613
	6.0	2.0	4.5	3.1	TB03623
	6.0	3.0	4.5	3.1	TB03633
	8.0	1.0	4.5	2.9	TB03813
	8.0	2.0	4.5	2.9	TB03823
	8.0	3.0	4.5	2.9	TB03833
	Abutments are supplied with RP0001 screw. Recommended torque 25Ncm. Also available separately				RP0001

### WP Ti Base Abutment Angular

	RH	GH	D1	D2	Catalog No.	
 WP Ti Base Abutment Angular <b>Engaged</b>	4.0	1.0	4.7	3.5	TB05413	
	4.0	2.0	4.7	3.5	TB05423	
	4.0	3.0	4.7	3.5	TB05433	
	6.0	1.0	4.7	3.4	TB05613	
	6.0	2.0	4.7	3.4	TB05623	
	6.0	3.0	4.7	3.4	TB05633	
	8.0	1.0	4.7	3.3	TB05813	
	8.0	2.0	4.7	3.3	TB05823	
	8.0	3.0	4.7	3.3	TB05833	
	 WP Ti Base Abutment Angular <b>Engaged Wide</b>	4.0	1.0	5.5	3.5	TB05413W
		4.0	2.0	5.5	3.5	TB05423W
		4.0	3.0	5.5	3.5	TB05433W
6.0		1.0	5.5	3.4	TB05613W	
6.0		2.0	5.5	3.4	TB05623W	
6.0		3.0	5.5	3.4	TB05633W	
	8.0	1.0	5.5	3.3	TB05813W	
	8.0	2.0	5.5	3.3	TB05823W	
	8.0	3.0	5.5	3.3	TB05833W	
Abutments are supplied with WP0001 screw. Recommended torque 25Ncm. Also available separately				WP0001		



## Angulated Tools

	Description	L	L2	D1	D2	Catalog No.
	Angulated Screw Extractor Hand Driver	24.7	10	1.4	9.4	RP6400
	Angulated Star Screw Hand Driver - Short 23.4L	23.4	9.0	1.4	9.4	RP6401
	Angulated Star Screw Hand Driver - Long 28.4L	28.4	14.0	1.4	9.4	RP6402
	Angulated Star Screw Torque Driver - Short 17.0L	17.0	11.0	1.4	7.0	RP6403
	Angulated Star Screw Torque Driver - Long 22.0L	22.0	16.0	1.4	7.0	RP6404
	Angulated Star Screw Handpiece Driver - Extra Short 20.0L	20.0	7.0	1.4	2.35	RP6405
	Angulated Star Screw Handpiece Driver - Short 25.0L	25.0	12.0	1.4	2.35	RP6406
	Angulated Star Screw Handpiece Driver - Long 30.0L	30.0	17.0	1.4	2.35	RP6407



## Digital Analogs

	Description	L	D1	Catalog No.		Description	Catalog No.		Description	L	D1	Catalog No.
	RP CloseFit™ Digital Analog	10.0	3.55	RP1000		Retaining Screw	RS1002		WP CloseFit™ Digital Analog	10.0	4.0	WP1000



## Screws

	Description	Catalog No.
	RP CloseFit™ Abutment Screw	RP0001
	WP CloseFit™ Abutment Screw	WP0001



## TMA - Multi Unit Screws

	Description	Catalog No.
	TMA Scan Body Screw	TM0001
	TMA Prosthetic Screw	RS3404

## STMA / TMA Scan Bodies | For Intra-oral and Desktop Scanner

	Description	L	D1	Catalog No.		Description	L	D1	Catalog No.
	Single TMA Scan Body	6.0	4.9	TM0006S		TMA Scan Body	6.0	4.9	TM0006
		9.0	4.9	TM0009S			9.0	4.9	TM0009

## STMA / TMA Cementing Cone & Temporary Cylinder

	Description	L	D1	D2	H	Catalog No.		Description	L	D1	D2	Catalog No.
	Single TMA Titanium Temporary	12.0	4.9	3.5	10.5	RS4900S		Single TMA Cementing Cone, low profile	4.9	5.5	3.2	TM0011S
	TMA Titanium Temporary	12.0	4.9	3.5	10.5	RS4900		TMA Cementing Cone, low profile	4.9	5.5	3.2	TM0011
								TMA Cementing Cone	4.9	4.9	3.8	TM0010

## Tool Drivers

	Description	L	Catalog No.		Description	L	Catalog No.
	Star Hand Driver Short	23.4	RP0064		Star Hand Driver Long	28.4	RP0004

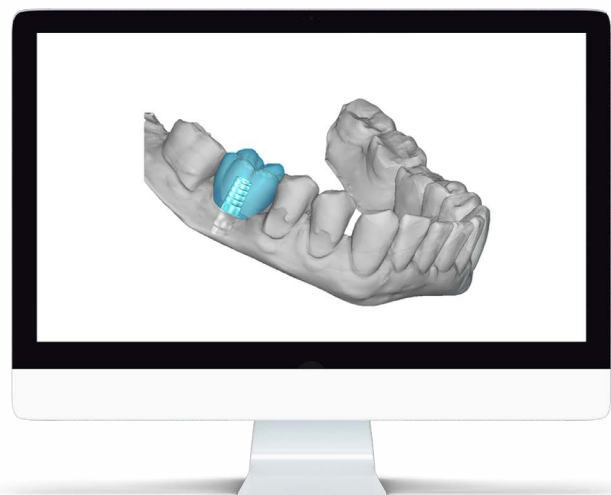

# TMA™ - Multi Unit Recommended Torque 35(Ncm)

Our TMA™ (Trans Mucosal Abutment) system is indicated for multiple-unit, screw-retained restorations, and may be used in combination with an implant-level framework design.

- Elevates restorative seating platform when implant-level restoration is not practical
- Provides better access when using implants with divergent angles
- Accommodates full and partial edentulous arches
- Available in straight or angled (17°, 30°, 45°) with different gingival heights
- Abutments are delivered with handles for easy insertion and seating

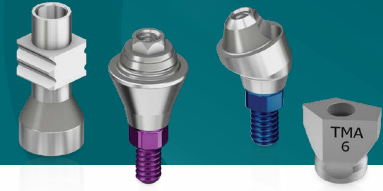



## RP TMA

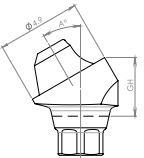

		Description	GH	Catalog No.				
		RP Straight Trans Mucosal Abutment	1.0	RP0032				
			2.0	RP0033				
			3.0	RP0034				
			4.0	RP3729				
			5.0	RP3730				
		RP Angled Trans Mucosal Abutment 17° 2.5mm	2.58	RP3734				
				RP Angled Trans Mucosal Abutment 17° 3.5mm	3.66	RP3735		
						RP Angled Trans Mucosal Abutment 30° 3mm	3.68	RP3737
								RP Angled Trans Mucosal Abutment 30° 4mm

## WP TMA



		Description	GH	Catalog No.				
		WP Straight Trans Mucosal Abutment	1.0	WP3731				
			2.0	WP3732				
			3.0	WP3733				
			4.0	WP3729				
			5.0	WP3730				
		WP Angled Trans Mucosal Abutment 17° 2.5mm	2.5	WP3734				
				WP Angled Trans Mucosal Abutment 17° 3.5mm	3.5	WP3737		
						WP Angled Trans Mucosal Abutment 30° 3mm	3.5	WP3735
								WP Angled Trans Mucosal Abutment 30° 4mm

		Description	GH	Catalog No.
		WP Angled Trans Mucosal Abutment 52° 5mm	4.8	WP3739
		WP Angled Trans Mucosal Abutment 60° 5mm	5.5	WP3740

## Transfers

	Description	L	D1	D2	Catalog No.
	TMA Impression Coping Open Tray	11.0	4.9	3.1	RS5006
	TMA Closed Tray Transfer	8.0	4.9	4.1	RS5011
	TMA Healing Cup	5.5	4.9	3.5	RS5005

## Analogs

	Description	L	D1	D2	Catalog No.
	TMA Abutment Replica	16.8	3.35	-	RS5004
	TMA Digital Model Replica Recommended torque 15(Ncm)	12.0	4.9	3.8	RS1001

  

	Description	L	D1	Catalog No.
	TMA Scan Body	6.0	4.9	TM0006
		9.0	4.9	TM0009



## TMA Screw For Scan Body & Cementing Cone

	Description	Catalog No.
	TMA Scan Body Screw	TM0001





## TMA Screw Temporary Cylinder & STMA Direct Option

	Description	Catalog No.
	TMA Prosthetic Screw	RS3404

## Snap-On

	Description	L	D1	D2	Catalog No.		Description	Catalog No.
	TMA Snap-On Transfer	8.0	4.9	3.2	RS5012		IRIS™, Impression coping	IR0179

## TMA Prosthetics

	Description	L	D1	D2	H	Catalog No.		Description	L	D1	D2	Catalog No.
	TMA Titanium Temporary	12.0	4.9	3.5	10.5	RS4900		TMA Cementing Cone, low profile	4.9	5.5	3.2	TM0011
	TMA Plastic Casting Sleeve /Prosthetic Screw	12.0	4.9	3.3	10.5	RS5001		TMA Cementing Cone	4.9	5.5	2.9	TM0010

# Overdenture Restoration

Recommended Torque 25(Ncm)



		Description	GH	RH	H	Catalog No.
		RP Ball Attachment	0.5	2.7	4.0	RP0051
			1.0	2.7	4.5	RP0052
			2.0	2.7	5.5	RP0053
			3.0	2.7	6.5	RP0054
			4.0	2.7	7.5	RP0055
			5.0	2.7	8.5	RP0056
		WP Ball Attachment	0.5	2.7	4.0	WP0051
			1.0	2.7	4.5	WP0052
			2.0	2.7	5.5	WP0053
			3.0	2.7	6.5	WP0054
			4.0	2.7	7.5	WP0055
			5.0	2.7	8.5	WP0056

	Description	L	Ø	Catalog No.
	Ball Attachment Replica	16.6	4.0	RS5740

	Description	L	Ø	D2	Catalog No.
	Plastic Ball Cap White (Nylon)	2.6	4.1	3.6	RS2660
	Plastic Ball Cap Pink Soft (Nylon)	2.6	4.1	3.6	RS2662
	Titanium Ball Cap	2.9	4.7	4.7	RS2670
	Stainless Steel Ball Cap	2.90	4.70	4.70	RS2675SS

# Grip™ - Overdenture Attachment

As an addition to our wide variety of prosthetic solutions.

Implant supported overdentures are among the most practical prosthetic solutions for patients who cannot utilize fixed restorations, or as an interim solution for patients who are waiting for the osseointegration process of their newly placed implants.

The Grip™ attachment system is a versatile solution, designed to ensure maximum denture retention and stability both for maxillary and mandibular dentures. The variety of retentive caps allow dentists to choose the required retention level needed for each individual case and can easily be replaced, when needed.

The Grip™ attachment system is available for Internal Hex in a range of gingival heights, to enable a reliable, long lasting and cost-effective solution for your patients.

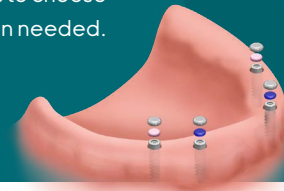
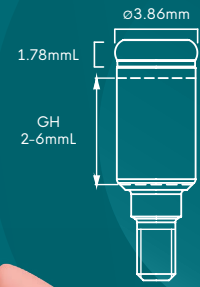

## RP Grip™ Abutments







	Description	Catalog No.
	Grip RP Abutment 1mm	RP0038
	Grip RP Abutment 2mm	RP0057
	Grip RP Abutment 3mm	RP0058
	Grip RP Abutment 4mm	RP0059
	Grip RP Abutment 5mm	RP0060
	Grip RP Abutment 6mm	RP0061

## WP Grip™ Abutments



	Description	Catalog No.
	Grip WP Abutment 1mm	WP0063
	Grip WP Abutment 2mm	WP0057
	Grip WP Abutment 3mm	WP0058
	Grip WP Abutment 4mm	WP0059
	Grip WP Abutment 5mm	WP0060
	Grip WP Abutment 6mm	WP0061

## Included in Sales Pack

### Grip™ Processing Set







	Description		Description	Catalog No.
	Housing		Light	RS6426
	Processing		Regular	
	Extra Light		Block Out Spacer	



	Description	Catalog No.
	Grip™ for TMA	TM0100
	Grip™ for Bar, M2 thread	RS0101





Or





### Grip™ Extended Range processing set

	Description		Description	Catalog No.
	Housing		Light	RS6427
	Processing		Regular	
	Zero		Block Out Spacer	
	Extra Light			



## Grip™ Retention Caps

Grip Retention 4 Pack		Description	Catalog No.
		Extra Light	RS6417
		Light	RS6418
		Regular	RS6419

Grip™ Extended Range Retention 4 Pack		Description	Catalog No.
		Zero	RS6420
		Extra Light	RS6421
		Light	RS6422
		Regular	RS6423

## Grip™ Accessories

	Description	Catalog No.		Description	Catalog No.
	Grip™ Impression Coping 4 Pack Includes RS6415 Grip™ Processing 4 Pack	RS6414		Grip™ Replica 4 Pack	RS2508
	Metal Housing 4 Pack Includes RS6415 Grip™ Processing 4 Pack	RS6413			Grip™ Processing 4 Pack
	Grip™ Block Out Spacer 4 Pack	RS6424			Grip™ Processing 20 Pack

## Grip™ Tools

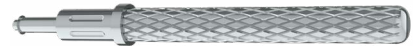
	Description	Catalog No.
	Grip™ core tool	RS6200

Designed for inserting and removing the Grip™ retention males from the metal housing

	Description	Catalog No.		Description	Catalog No.		Description	Catalog No.
	Star Hand Driver Short	RP0064		1.27 Hex torque driver-long	RS6082		1.27 Hex driver for handpiece - long	RS9035
	Star Hand Driver Long	RP0004		1.27 Hex torque driver-short	RS6080		1.27 Hex driver for handpiece - short	RS9030

# Surgical Kits

Successful surgical procedures start with having the right instruments and tools to ensure your desired treatment outcomes are met.

That's why our range has everything you need, including drills, keys, ratchets and insertion tools.

Not only do they make procedures safer and simpler, they result in an enhanced patient experience as well.

Our Surgical Kits streamline and simplify your implant procedures.



# Premium Kit CF6300

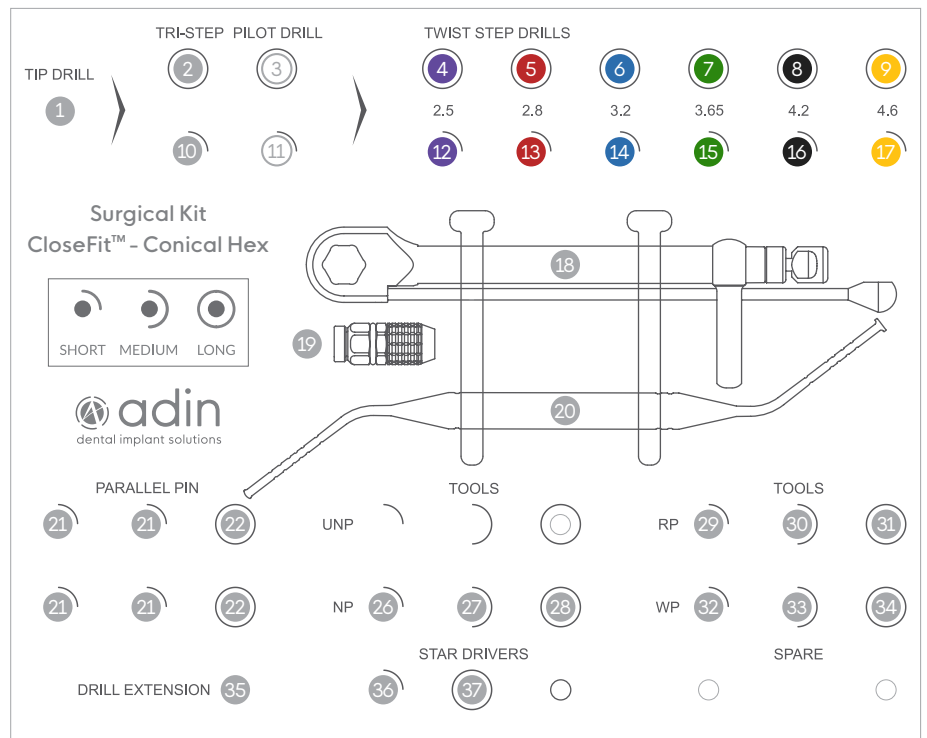

		Drills	Catalog No.
1		Tip Drill	RS8032
2		Tri-Step Drill - Long	TD2218
3		Pilot Drill 2mmD x 8-18mmL	DL1820
4		Twist Step Drill 1.8/2.5mmD x 8-18mmL	DL1825
5		Twist Step Drill 2.3/2.8mmD x 8-18mmL	DL1828
6		Twist Step Drill 2.8/3.2mmD x 8-18mmL	DL1832
7		Twist Step Drill 3.2/3.6mmD x 8-18mmL	DL1836
8		Twist Step Drill 3.8/4.2mmD x 8-18mmL	DL1842
9		Twist Step Drill 4.2/4.6mmD x 8-18mmL	DL1846
10		Tri-Step Drill - Short	TD1511
11		Pilot Drill 2mmD x 6-13mmL	DL1320
12		Twist Step Drill 1.8/2.5mmD x 6-13mmL	DL1325
13		Twist Step Drill 2.3/2.8mmD x 6-13mmL	DL1328
14		Twist Step Drill 2.8/3.2mmD x 6-13mmL	DL1332
15		Twist Step Drill 3.2/3.6mmD x 6-13mmL	DL1336
16		Twist Step Drill 3.8/4.2mmD x 6-13mmL	DL1342
17		Twist Step Drill 4.2/4.6mmD x 6-13mmL	DL1346

		Surgical Tools	Catalog No.
18		Surgical Torque Ratchet 35-100 Ncm	RS6111
19		Wrench Ratchet Surgical Instruments Handle	RA0050
20		Depth Probe	RS6180

		Parallel Pins	Catalog No.
21		Parallel Pin Short 11mm (qty. 4)	RS6150
22		Parallel Pin Short 16mm (qty. 2)	RS6155

		Insertion Tools	Catalog No.
26		NP 2mm Hex Handpiece Adapter - Short	NP0068
27		NP 2mm Hex Handpiece Adapter - Medium	NP0071
28		NP 2mm Hex Handpiece Adapter - Long	NP0074
29		RP 2.25mm Hex Handpiece Adapter - Short	RP0068
30		RP 2.25mm Hex Handpiece Adapter - Medium	RP0071
31		RP 2.25mm Hex Handpiece Adapter - Long	RP0074
32		WP 2.65mm Hex Handpiece Adapter - Short	WP0068
33		WP 2.65mm Hex Handpiece Adapter - Medium	WP0071
34		WP 2.65mm Hex Handpiece Adapter - Long	WP0074

		Drill Extension	Catalog No.
35		Drill Extension	RS9027

		Hex Drivers	Catalog No.
36		Star Hand Driver - Short	RP0064
37		Star Hand Driver - Long	RP0004

\*Products may be ordered separately as an addition to the kit

# Advanced Kit CF6302

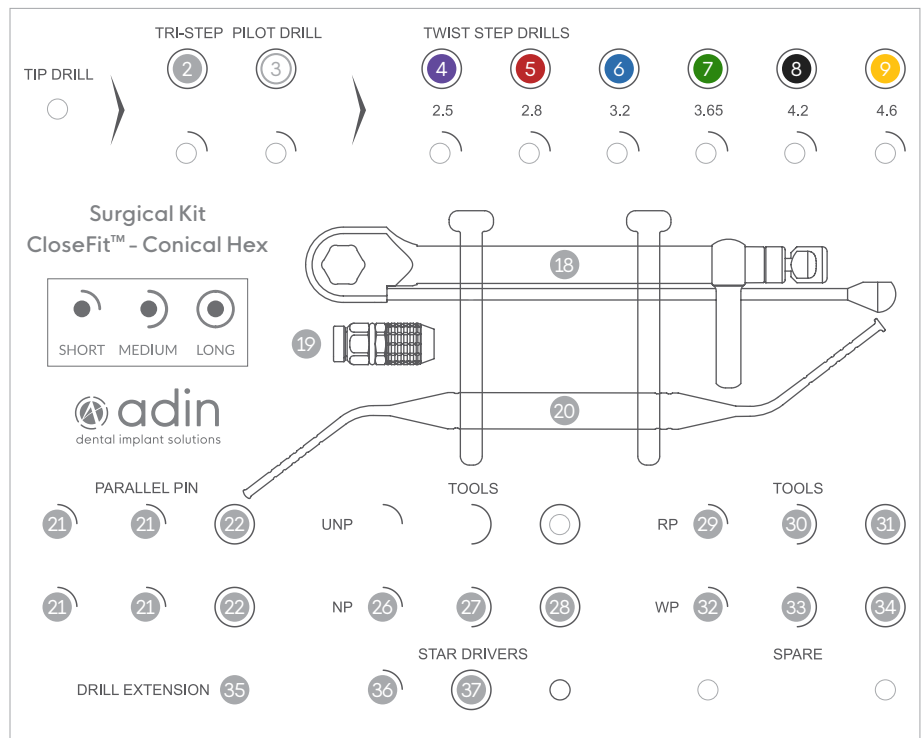

		Drills	Catalog No.
3		Pilot Drill 2mmD x 8-18mmL	DL1820
4		Twist Step Drill 2.3/2.8mmD x 8-18mmL	DL1828
5		Twist Step Drill 2.8/3.2mmD x 8-18mmL	DL1832
6		Twist Step Drill 3.2/3.6mmD x 8-18mmL	DL1836
7		Twist Step Drill 3.8/4.2mmD x 8-18mmL	DL1842
8		Twist Step Drill 4.2/4.6mmD x 8-18mmL	DL1846

		Surgical Tools	Catalog No.
18		Surgical Torque Ratchet 35-100 Ncm	RS6111
19		Wrench Ratchet Surgical Instruments Handle	RA0050
20		Depth Probe	RS6180

		Parallel Pins	Catalog No.
21		Parallel Pin Short 11mm (qty. 4)	RS6150
22		Parallel Pin Short 16mm (qty. 2)	RS6155

		Insertion Tools	Catalog No.
26		NP 2mm Hex Handpiece Adapter - Short	NP0068
27		NP 2mm Hex Handpiece Adapter - Medium	NP0071
28		NP 2mm Hex Handpiece Adapter - Long	NP0074
29		RP 2.25mm Hex Handpiece Adapter - Short	RP0068
30		RP 2.25mm Hex Handpiece Adapter - Medium	RP0071
31		RP 2.25mm Hex Handpiece Adapter - Long	RP0074
32		WP 2.65mm Hex Handpiece Adapter - Short	WP0068
33		WP 2.65mm Hex Handpiece Adapter - Medium	WP0071
34		WP 2.65mm Hex Handpiece Adapter - Long	WP0074

		Drill Extension	Catalog No.
35		Drill Extension	RS9027

		Hex Drivers	Catalog No.
36		Star Hand Driver - Short	RP0064
37		Star Hand Driver - Long	RP0004

\*The advanced kit is also available with short drills | Catalog No. CF6304

# Starter Kit CF6303

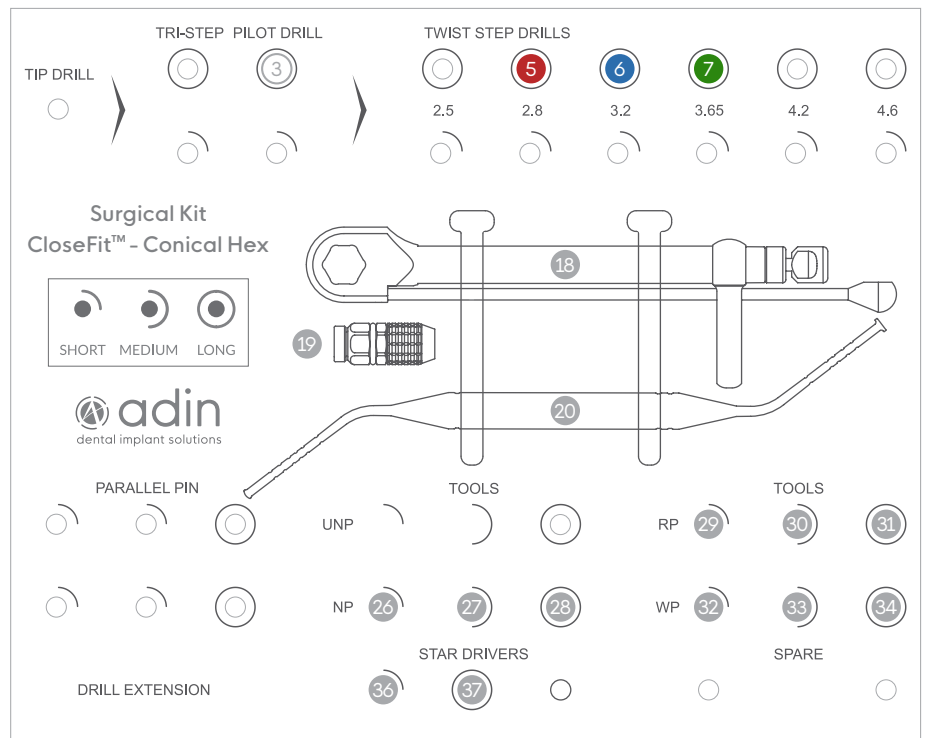

		Drills	Catalog No.
3		Pilot Drill 2mmD x 8-18mmL	DL1820
4		Twist Step Drill 2.3/2.8mmD x 8-18mmL	DL1828
5		Twist Step Drill 2.8/3.2mmD x 8-18mmL	DL1832
6		Twist Step Drill 3.2/3.6mmD x 8-18mmL	DL1836
7		Twist Step Drill 3.8/4.2mmD x 8-18mmL	DL1842

		Insertion Tools	Catalog No.
26		NP 2mm Hex Handpiece Adapter - Short	NP0068
27		NP 2mm Hex Handpiece Adapter - Medium	NP0071
28		NP 2mm Hex Handpiece Adapter - Long	NP0074
29		RP 2.25mm Hex Handpiece Adapter - Short	RP0068
30		RP 2.25mm Hex Handpiece Adapter - Medium	RP0071
31		RP 2.25mm Hex Handpiece Adapter - Long	RP0074
32		WP 2.65mm Hex Handpiece Adapter - Short	WP0068
33		WP 2.65mm Hex Handpiece Adapter - Medium	WP0071
34		WP 2.65mm Hex Handpiece Adapter - Long	WP0074

		Surgical Tools	Catalog No.
20		Wrench Ratchet	RS6100
21		Wrench Ratchet Surgical Instruments Handle	RA0050

		Hex Drivers	Catalog No.
36		Star Hand Driver - Short	RP0064
37		Star Hand Driver - Long	RP0004

# Drills and Tools

Our DLC (Diamond Like Carbon) Tri-Step/Twist Step Surgical Drills are uniquely designed and coated to improve the surgical drilling process.

Tri-Step & Twist-Step DLC drills simplify the cutting process, save time and minimize risks.

Our improved DLC drill coating provides state-of-the-art hardness and slickness that increases lifespan of the drill, maintains sharpness for extended drilling and generates less heat, thereby reducing chances of heating the bone or complications arising from conventional drilling protocols.

The drills come in the following diameters (mm): 2.0, 2.5, 2.8, 3.2, 3.6, 4.2, 4.6, 5.2, 5.6

Specially designed for Adin's implants and suitable for their simple and convenient drilling protocol.

They are clearly and conveniently marked and can be used with or without drill stops.



## Tri-Step drills









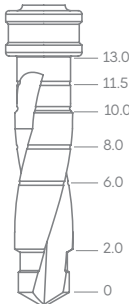

Adin's Tri-Step drills condense drilling protocols and avoid the need for using multiple drills throughout complex procedures.

Because friction at the cutting site is reduced, complications common with high speed drilling are decreased and faster & better recovery can occur.









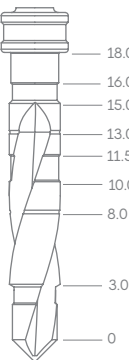

L		Ø	Size	Catalog No.
		1.8-3.2	Short	TD1511
		1.8-3.2	Long	TD2218

## Twist Step drills

### Short 6-13mm





L		∅	Color	Catalog No.
		2.0	White	DL1320
		1.8-2.5	Purple	DL1325
		2.3-2.8	Red	DL1328
		2.8-3.2	Blue	DL1332
		3.2-3.6	Green	DL1336
		3.9	Pink	DL1339
		3.8-4.2	Black	DL1342
		4.2-4.6	Yellow	DL1346
		4.8-5.2	Brown	DL1352
		5.2-5.6	Grey	DL1356

### Long 8-18mm











L		∅	Color	Catalog No.
		2.0	White	DL1820
		1.8-2.5	Purple	DL1825
		2.3-2.8	Red	DL1828
		2.8-3.2	Blue	DL1832
		3.2-3.6	Green	DL1836
		3.9	Pink	DL1839
		3.8-4.2	Black	DL1842
		4.2-4.6	Yellow	DL1846
		4.8-5.2	Brown	DL1852
		5.2-5.6	Grey	DL1856

# Surgical Tools















	Description	Catalog No.
	Surgical Torque Ratchet 35-100 Ncm	RS6111
	Prosthetic Torque Ratchet 15-35 Ncm	RS6112
	Wrench Ratchet	RS6100
	Surgical Driver	RS7001
	Depth Probe	RS6180



# Hand & Torque Drivers Recommended Torque 25(Ncm)

	Description	Catalog No.
	Star Hand Driver 23.4mm *For Angled TMA/TMA prosthetic screw	RP0064
	Star Hand Driver 23.4mm *For Angled TMA/TMA prosthetic screw	RP0004
	TMA/FC Female Hand Hex Driver 22.4mm *For straight TMA/Flat connection	RS6193
	TMA/FC Female Hand Hex Driver 28.4mm *For straight TMA/Flat connection	RS6191
	RP 2.2mm Hex Torque Driver Short 20.0L	RP0067
	RP 2.2mm Hex Torque Driver-Long 25.0L	RP0066
	WP 2.6mm Torque Driver Short 20.0L	WP0067
	WP 2.6mm Torque Driver-Long 25.0L	WP0066
	Star Torque Driver Short 20.40L *For Angled TMA/TMA prosthetic screw	RP0065
	Star Torque Driver - Long 25.4L *For Angled TMA/TMA prosthetic screw	RP0005
	TMA/FC Hex Torque Driver - Short 20.0L *For straight TMA/Flat connection	RS6197





## Handpiece Drivers Recommended Torque 35(Ncm)

	Description	Catalog No.
	TMA/FC Hex Torque Driver Long 25.0L For straight TMA/Flat connection	RS6196
	Torque Driver for Ball Attachment 16.7L	RS6090
	Wrench Ratchet Surgical Instruments Handle 16.7mm	RA0050
	RP 2.25mm Hex Handpiece Adapter Short 23.7L	RP0068
	RP 2.25mm Hex Handpiece Adapter Medium 27.6L	RP0071
	RP 2.25mm Hex Handpiece Adapter Long 36.0L	RP0074
	Star Handpiece Driver - Short 25.0L *For Angled TMA/TMA prosthetic screw	RP0018
	Star Handpiece Driver - Long 30.0L *For Angled TMA/TMA prosthetic screw	RP0019
	RP Handpiece Hex Adapter - Short 20.0L	RP0062
	RP Handpiece Hex Adapter - Long 25.0L	RP0072
	TMA/FC Hex Handpiece Adapter - Short 20.0L *For straight TMA/Flat connection	RS6194
	TMA/FC Hex Handpiece Adapter - Long 25.0L *For straight TMA/Flat connection	RS6195A

## Tools

	Description	Catalog No.
	Parallel Pin 11mm	RS6150
	Parallel Pin 16mm	RS6155
	Drill Extension	RS9027

## Osteotomes

	Description	Catalog No.
	Osteotome Handle	HA0074
	Osteotome Insert 2.0mmD	HA0061
	Osteotome Insert 2.8mmD	HA0064
	Osteotome Insert 3.25mmD	HA0067
	Osteotome Insert 3.65mmD	HA0070

# Guided Surgery

The adinguide™ was created with you in mind, bringing the guided surgery world to your clinic.

The kits were specifically designed to support effortless procedures, accurate and predictable implant placement.

The ActiveFlow™ Irrigation Technology is a unique design that forces coolant through the guide to ensure irrigation reaches the bone and prevents overheating.

The adinguide™ drills are designed with carved channels which allow saline coolant from your hand-piece to stream through the sleeve directly into the osteotomy site while drilling.

Our uniquely designed drill kit is intuitive and easy to use by implant diameter and length.

The Tissue Punch and Pilot Drill allow for easy flapless access.

Keyless procedure enables easy handling and full visibility of surgical field.

**Self-centering drills-** controlled by a 5.5mm diameter cylinder at the top of each drill centers the drill in the guide's sleeve.

**Self-centering cylinder** engages the sleeve before the drill engages the osteotomy in order to ensure correct positioning of the drill.

**Built-in stoppers-** ensure precise and accurate drilling to the desired depth.



# Guided Surgery Kit Implants Drills GSK001



	Drills	Catalog No.		Drills	Catalog No.
1		GS5055	5		GS0638
2		GS0625	9		GS0838
3		GS0825	13		GS1038
7		GS1025	17		GS1138
11		GS1125	21		GS1338
15		GS1325	24		GS1638
19		GS1625	6		GS0646
4		GS0632	10		GS0846
8		GS0832	14		GS1046
12		GS1032	18		GS1146
16		GS1132	22		GS1346
20		GS1332	25		GS1646
23		GS1632			



For full  
guided  
procedure:



# Guided Surgery Kit CloseFit™ RP/WP Implants Tools GSK004

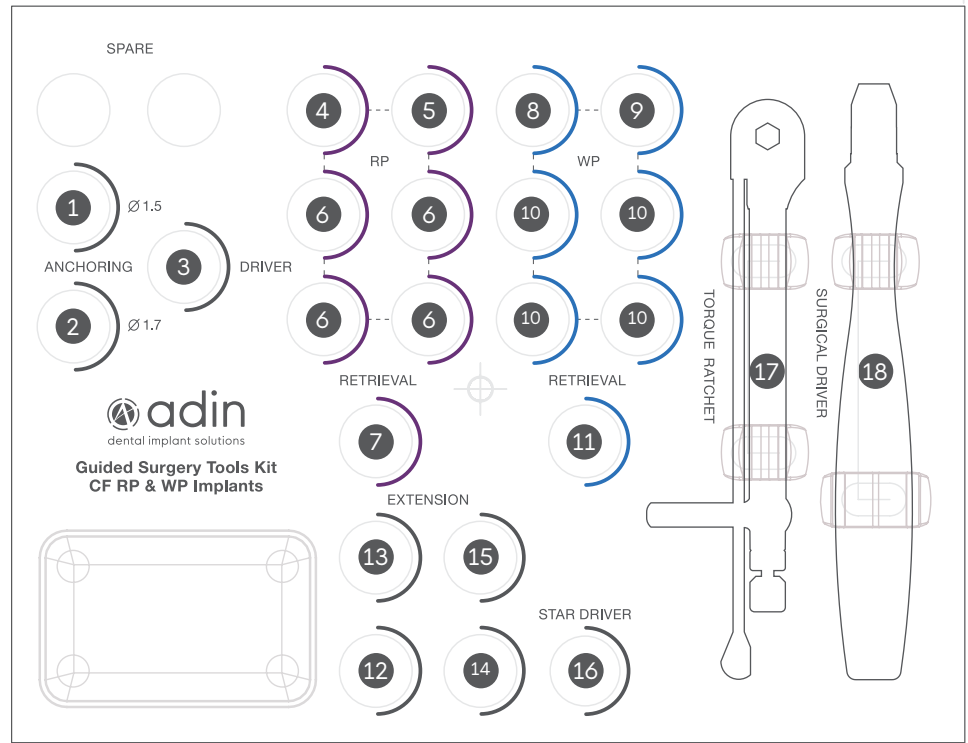

	Description	Catalog No.		Description	Catalog No.
1	Anchoring Drill S-2.0, 2.0/1.5mmDx19mmL	GS1915	12	Manual Socket L10.5	GS0023
2	Anchoring Drill S-2.0, 2.0/1.7mmDx19mmL	GS1917	13	Manual Socket L14.5	GS0024
3	Handpiece Guide Fixation Screw Driver	GS0028	14	Handpiece Socket L10.5	GS0021
4	Guided RP Handpiece Fixture Mount S-5.5	GS0041	15	Drill Extension	RS9027
5	Guided RP Ratchet Fixture Mount S-5.5	GS0043	16	Star Hand Driver - Long	RP0004
6	Guided RP Ratchet Fixture Mount S-5.5, Screw Retained	GS0037	17	Surgical Torque Ratchet 35-100 Ncm for hex 4mm	GS6111
7	RP Ratchet retrieval tool	GS0046	18	Guide Fixation Screw Driver	GS0027
8	Guided WP Handpiece Fixture Mount S-5.5	GS0042			
9	Guided WP Ratchet Fixture Mount S-5.5	GS0044			
10	Guided WP Ratchet Fixture Mount S-5.5, Screw Retained	GS0039			
11	WP Ratchet retrieval tool	GS0047			



For full  
guided  
procedure:



CloseFit™ RP/WP  
Implant Platform





GS Tools Kit RS  
GSK001







5.5mmD Sleeve  
GS0055



### 18mm Drills

	Description	Catalog No.
	Drill S-5.5, 2.5/1.8mmDx18.0mmL	GS1825
	Drill S-3.3, 2.5/1.8mmDx18.0mmL	GSN1825

### Accessories

	Description	Purchase Options	Catalog No.
	Guided Vertical Fixation Screw S-3.3	x3 pack	GS0006
	2.0mmD Anchoring Screw	x3 pack	GS1920
	2.0mmD Anchoring Sleeve	x3 pack	GS0020
	3.3mmD Narrow Implants Sleeve	x1 pack	GS0033
		x3 pack	GS0033x3
		x10 pack	GS0033x10
	5.5mmD Sleeve	x1 pack	GS0055
		x3 pack	GS0055x3
		x10 pack	GS0055x10

\* Illustrations are not to scale

\* Availability of the products in some places is limited and depends on local regulations.

\* For more information, please contact your local representative.

