



UniFit™



UniFit™

Introducing UniFit™, your Unified Connection to hassle-free implants. With 30 years of implantology knowledge and experience, we have taken the best of our platforms and combined them into our new UniFit™ implant.

Surgical and restoration procedures can be complicated, which is why we are focused on making them simple. With UniFit, one prosthetic connection fits all.

This means that ALL prosthetics and attachments fit ALL size and diameter UniFit implants. This means:

No need for spares, no multiple sizes for handpieces, no extra storage for all the extra prosthetics!

Our innovative implant design features a friction 7° conical connection with a six-position star shape index that allows for one unified prosthetic connection to fit all implant diameters. This simplifies surgical and restoration procedures, making the process faster and more efficient.

UniFit™ ensures a solid fixture of the abutment, enhancing the implant-abutment seal and minimizing micromovements. Our unique design also enables simple yet flexible implant and abutment alignment, allowing for self-guiding insertion and clear-cut tactile feedback.

The external geometry and surface of UniFit™ are designed for immediate function and loading, providing optimal stability in all bone types. Every feature of UniFit™ is designed to enhance the success of the procedure and deliver better results, ensuring a better experience for both doctors and patients.

In short, the concept behind UniFit™ is simple, but the results are immediate. Say goodbye to complicated dental implant procedures and hello to a hassle-free experience with UniFit™.

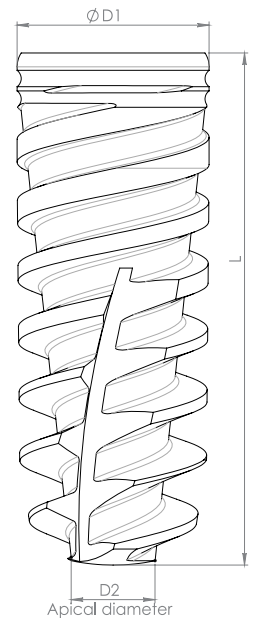
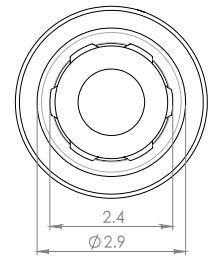

Built-In Platform Switching

Minimally invasive surgery

OsseoFix™ surface

Bone-condensing property
Self-drilling

Rounded apex



Back tapered collar

Micro Threads:
Engineered to enhance bone regeneration, prevent bone loss & increase bone implant contact

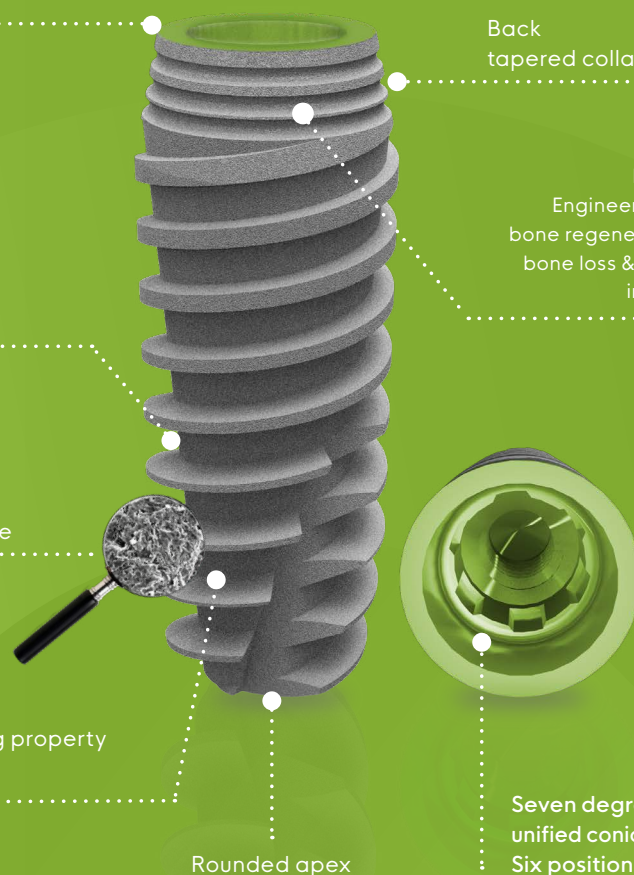
Seven degrees unified conical connection
Six position star index



Recommended insertion torque up to 50 Ncm

	D1	L	D2	Catalog No.
	3.5	8.0	1.50	ISPUF0835
		10.0	1.50	ISPUF1035
		11.5	1.50	ISPUF1135
		13.0	1.50	ISPUF1335
		16.0	1.50	ISPUF1635
		18.0	1.50	ISPUF1835
	3.75	8.0	1.60	ISPUF0838
		10.0	1.60	ISPUF1038
		11.5	1.60	ISPUF1138
		13.0	1.60	ISPUF1338
		16.0	1.60	ISPUF1638
		18.0	1.60	ISPUF1838
	4.3	6.0	2.00	ISPUF0643
		8.0	1.90	ISPUF0843
		10.0	1.90	ISPUF1043
		11.5	1.90	ISPUF1143
		13.0	1.90	ISPUF1343
		16.0	1.90	ISPUF1643
	18.0	1.90	ISPUF1843	

	D1	L	D2	Catalog No.
	5.0	6.0	2.50	ISPUF0649
		8.0	2.25	ISPUF0849
		10.0	2.25	ISPUF1049
		11.5	2.25	ISPUF1149
		13.0	2.25	ISPUF1349
		16.0	2.25	ISPUF1649
	6.0	6.0	3.50	ISPUF0660
		8.0	3.50	ISPUF0860
		10.0	3.50	ISPUF1060
		11.5	3.50	ISPUF1160
		13.0	3.50	ISPUF1360

Radiographic Template UniFit™ | ASD0617

Drill Sequence for UniFit™ Recommended drilling speed up to 1200 rpm

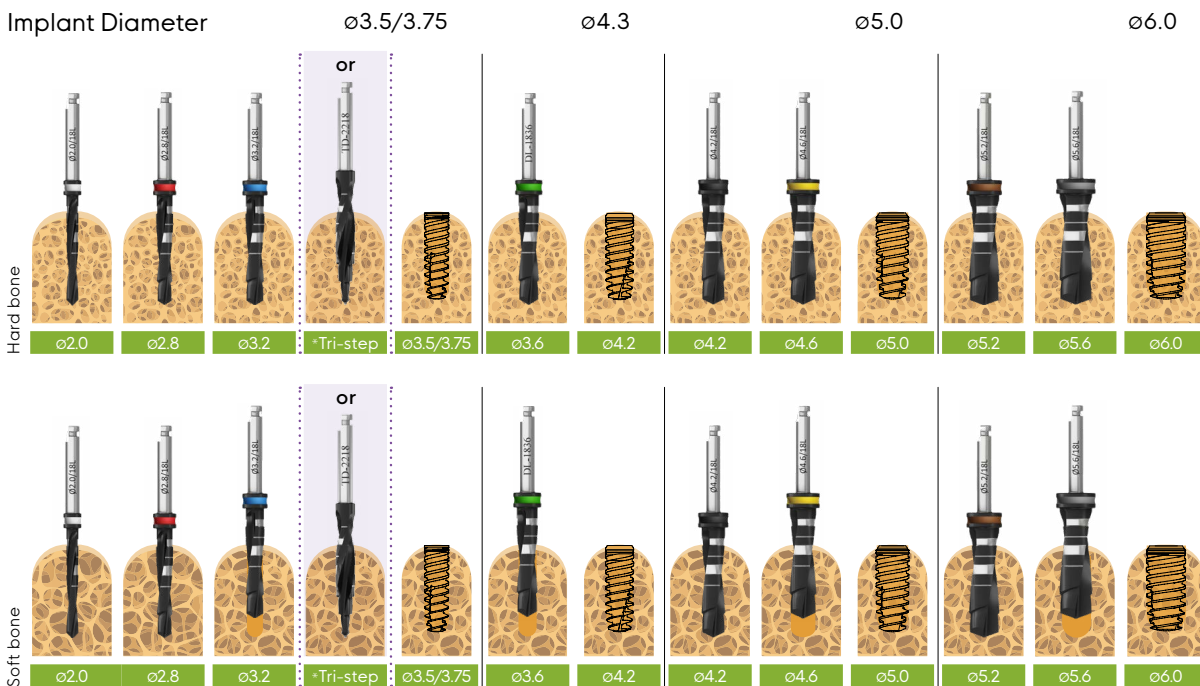

All measurements are in mm.

*For initial drilling, you may use Tri-step drill instead of $\varnothing 2$, $\varnothing 2.8$ and $\varnothing 3.2$ drills in sequence.

Note: (x.xx) Drill to the depth of the cortex only. All measurements are in mm.

⚠ CAUTION: The drill preparation is up to 1mm longer than the implant. * The drill apical step = 1.8mmD

Cover Screw & Healing Abutments

Recommended Torque 15(Ncm)







Cover Screw Packed with implant

		Description	Catalog No.
		Cover Screw	UF0073

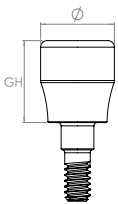
Healing Abutments

		Description	GH	Ø	Catalog No.
		UniFit Slim Conical Healing Abutment	2.0	3.5	UF0095
			3.0	3.5	UF0096
			4.0	3.5	UF0097
			5.0	3.5	UF0098
			6.0	3.5	UF0099
		UniFit Regular Conical Healing Abutment	2.0	4.5	UF0090
			3.0	4.5	UF0091
			4.0	4.5	UF0092
			5.0	4.5	UF0093
			6.0	4.5	UF0094
		UniFit Wide Conical Healing Abutment	2.0	5.5	UF0095W
			3.0	5.5	UF0096W
			4.0	5.5	UF0097W
			5.0	5.5	UF0098W
			6.0	5.5	UF0099W

		Description	GH	Ø	Catalog No.
		UniFit Slim Healing Abutment	2.0	3.5	UF0046
			3.0	3.5	UF0047
			4.0	3.5	UF0048
			5.0	3.5	UF0049
			6.0	3.5	UF0050
		UniFit Regular Healing Abutment	2.0	4.5	UF0022
			3.0	4.5	UF0023
			4.0	4.5	UF0024
			5.0	4.5	UF0025
			6.0	4.5	UF0026
		UniFit Wide Healing Abutment	2.0	5.5	UF0046W
			3.0	5.5	UF0047W
			4.0	5.5	UF0048W
			5.0	5.5	UF0049W
			6.0	5.5	UF0050W

Impression Recommended Torque 15(Ncm)

Our components for taking impressions for all restoration types can be successfully utilized for digital or conventional protocols either implant-level or abutment level procedures.

Our broad range of solutions and flexible designs enable easy and accurate restorative planning, whether you're dealing with a single tooth, multiple teeth, bridge or full mouth rehabilitation.



Transfers | Recommended Torque 15(Ncm)

	Open Tray	Description	L	D1	H	Catalog No.
		Unifit Open Tray Transfer Short	19.0	6.0	10.0	UF5610
		Unifit Open Tray Transfer Long	23.0	6.0	14.0	UF5614

	Close Tray	Description	L	D1	H	Catalog No.
		Unifit Close Tray Transfer Short	11.0	3.4	9.0	UF5109
		Unifit Close Tray Transfer Long	15.0	3.4	13.0	UF5113

Scan Bodies

	Description	H	Catalog No.		Description	H	Catalog No.
	UniFit Scan Body	7	UF0088		UniFit Scan Body	10	UF0089







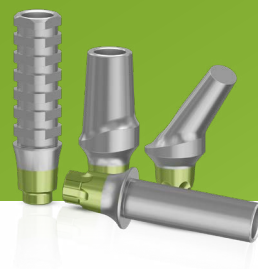

Analogs

	Description	L	D1	Catalog No.		Description	Catalog No.		Description	L	D1	Catalog No.
	UniFit Digital Model Analog	10.0	3.55	UF1000		Retaining Screw	RS1002		UniFit Implant Analog	12.6	3.6	UF0007





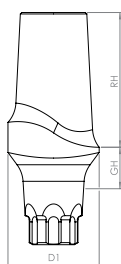

Temporary & Cement Retained Restoration

Recommended Torque 35(Ncm)



	Description	D1	GH	RH	Catalog No.
	UniFit Engaging Temporary Abutment Slim 3.5mmD	3.5	2	9.5	UF0036
	UniFit Non-Engaging Temporary Abutment Slim 3.5mmD	3.5	2	9.5	UF0037
	UniFit Engaging Temporary Abutment 4.5mmD	4.5	2	9.5	UF0043
	UniFit Engaging Temporary Abutment Wide 5.5mmD	5.5	2	9.5	UF0043W
	UniFit Non-Engaging Temporary Abutment 4.5mmD	4.5	2	9.5	UF0044
	UniFit Non-Engaging Temporary Abutment Wide 5.5mmD	5.5	2	9.5	UF0044W
	UniFit Straight Abutment	4.4	3.0	6.5	UF0010
		4.4	2.0	6.5	UF0011
		4.4	1.0	6.5	UF0012
	UniFit Straight Abutment Wide	5.1	3.0	6.5	UF0010W
		5.1	2.0	6.5	UF0011W
		5.1	1.0	6.5	UF0012W
	UniFit Straight Abutment Long	4.4	1.0	12.5	UF1251
		4.4	2.0	12.5	UF1252
		4.4	3.0	12.5	UF1253
	UniFit Straight Abutment Long Wide	5.1	1.0	12.5	UF1251W
		5.1	2.0	12.5	UF1252W
		5.1	3.0	12.5	UF1253W
	UniFit Straight Slim Abutment No End Line	4.0	2.3	6.0	UF0020



		Description	D1	GH	RH	Catalog No.
		UniFit Angled Abutment 15°	4.4	1.0	6.5	UF0013
			4.4	2.0	6.5	UF0014
			4.4	3.0	6.5	UF0015
		UniFit Angled Abutment Wide 15°	5.1	1	6.5	UF0013W
			5.1	2	6.5	UF0014W
			5.1	3	6.5	UF0015W
		UniFit Angled Abutment 25°	4.4	1.5	6.5	UF2515
			4.4	3.0	6.5	UF2530
		UniFit Angled Abutment Wide 25°	5.1	1.5	6.5	UF2515W
			5.1	3	6.5	UF2530W
		UniFit Angled Abutment Wide 35°	5.1	1.5	6.5	UF3515W
			5.1	3	6.5	UF3530W

Screw - Retained Restoration Casting Abutments

Recommended Torque 35(Ncm)

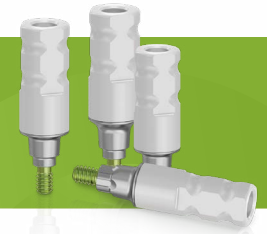

		Description	D1	GH	RH	Catalog No.	
		UniFit Plastic Cylinder Abutment Slim 3.5mmD	3.5	2	9.5	UF0038	
			UniFit Plastic Cylinder Abutment 4.5mmD	4.5	2	9.5	UF0045
			UniFit Plastic Cylinder Abutment Wide 5.5mmD	5.5	2	9.5	UF0045W
		UniFit Engaging Cobalt Chrome/Plastic Abutment	3.9	1	10	UF3094	
		UniFit Engaging Titanium/Plastic Abutment	4.7	1.5	10	UF3095	
		UniFit Non-Engaging Titanium/Plastic Abutment	4.7	1.5	10	UF3097	
		UniFit Non-Engaging Cobalt Chrome/Plastic Abutment	3.9	1	10	UF3100	
		UniFit Engaging Cobalt Chrome/Plastic Abutment Wide	4.6	1	10	UF3094W	
		UniFit Engaging Titanium/Plastic Abutment Wide	5.2	1.5	10	UF3095W	
		UniFit Non-Engaging Titanium/Plastic Abutment Wide	5.2	1.5	10	UF3097W	
		UniFit Non-Engaging Cobalt Chrome/Plastic Abutment Wide	4.6	1	10	UF3100W	

Single TMA™ Recommended Torque 35(Ncm)

Adin's range of screw-retained restorations has expanded to include the single TMA (STMA). This option offers the benefits of TMA abutments while still allowing for accurate and flexible restoration of a single tooth.

With Adin's STMA, you can combine the advantages of a trans-gingival approach and a screw-retained single tooth restoration, resulting in increased flexibility in terms of aesthetics, safety, and maintenance.

The Single TMA also includes a hex index that provides the necessary accuracy for positioning and retention to support a single tooth crown. You can choose from open and closed tray transfers, and scan bodies for digital impressions, and replicas are available to streamline the work process.



		Description	GH	Catalog No.
		UniFit Straight Single TMA 1mm	1.0	UF0032S
		UniFit Straight Single TMA 2mm	2.0	UF0033S
		UniFit Straight Single TMA 3mm	3.0	UF0034S
		UniFit Straight Single TMA 4mm	4.0	UF3729S
		UniFit Straight Single TMA 5mm	5.0	UF3730S
		UniFit Angled Single TMA 17° 2.5mm	2.5	UF3734S
		UniFit Angled Single TMA 30° 3mm	3.0	UF3735S
		UniFit Angled Single TMA 17° 3.5mm	3.5	UF3737S
		UniFit Angled Single TMA 30° 4mm	4.0	UF3738S

Transfers

	Description	L	D1	D2	Catalog No.		Description	L	D1	D2	Catalog No.
	Single TMA Impression Coping Open Tray	11.0	4.9	3.1	RS5006S		Single TMA Closed Tray Transfer	8.0	4.9	4.1	RS5011S

Snap-On

	Description	L	D1	D2	Catalog No.		Description	Catalog No.
	Single TMA Snap-On Transfer	8.0	4.9	3.2	RS5012S		IRIS™, Impression coping	IR0179

Analogues

	Description	L	D1	Catalog No.		Description	L	D1	D2	Catalog No.
	Single TMA Abutment Replica	16.8	3.35	RS5004S		Single TMA Digital Model Replica Recommended torque 15(Ncm)	12.0	4.9	3.8	RS1001S

Scan Bodies

	Description	L	D1	Catalog No.
	Single TMA Scan Body	6.0	4.9	TM0006S
		9.0	4.9	TM0009S





STMA Screw For Scan Body & Cementing Cone

	Description	Catalog No.
	TMA Scan Body Screw	TM0001

STMA Screw Temporary Cylinder & STMA Direct Option

	Description	Catalog No.
	TMA Prosthetic Screw	RS3404

STMA Prosthetics

	Description	L	D1	D2	H	Catalog No.
	Single TMA Titanium Temporary	12.0	4.9	3.5	10.5	RS4900S
	Single TMA Plastic Casting Sleeve w/Prosthetic Screw	12.0	4.9	3.3	10.5	RS5001S
	Single TMA Healing Cup	5.5	4.9	3.5	-	RS5005S
	Single TMA Cementing Cone, low profile	4.9	5.5	3.2	-	TM0011S

Tool Drivers | For Angled TMA/TMA Prosthetic Screws

	For Angled TMA/TMA prosthetic screw	L	Catalog No.
	Star Hand Driver Short	23.4	RP0064
	Star Hand Driver Long	28.4	RP0004





CAD CAM







Adin's CAD - CAM components and digital libraries enable clinicians and technicians to design and manufacture state-of-the-art restorations supported by Adin's implants, using current digital restoration processes.

The variety of components ensures endless restorative options for treatment of single, multiple, partially, or fully edentulous cases.

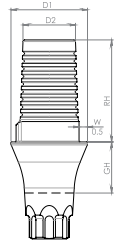

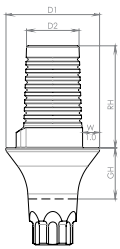
	Description	H	Catalog No.		Description	H	Catalog No.
	UniFit Scan Body	7	UF0088		UniFit Scan Body	10	UF0089

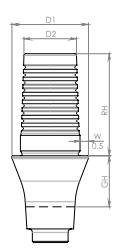
Ti Base Abutments | Recommended Torque 35(Ncm)

	Description	RH	GH	D1	D2	Catalog No.
	 <p>Ti Base UniFit Abutment, Engaged</p>	4.0	1.0	4.5	3.2	TB07411
		4.0	2.0	4.5	3.2	TB07421
		4.0	3.0	4.5	3.2	TB07431
		4.0	4.0	4.5	3.2	TB07441
		6.0	1.0	4.5	3.1	TB07611
		6.0	2.0	4.5	3.1	TB07621
		6.0	3.0	4.5	3.1	TB07631
		6.0	4.0	4.5	3.1	TB07641
		8.0	1.0	4.5	2.9	TB07811
		8.0	2.0	4.5	2.9	TB07821
		8.0	3.0	4.5	2.9	TB07831
		8.0	4.0	4.5	2.9	TB07841
	 <p>Ti Base UniFit Abutment, Engaged Wide</p>	4.0	1.0	5.5	3.2	TB07411W
		4.0	2.0	5.5	3.2	TB07421W
		4.0	3.0	5.5	3.2	TB07431W
		4.0	4.0	5.5	3.2	TB07441W
		6.0	1.0	5.5	3.1	TB07611W
		6.0	2.0	5.5	3.1	TB07621W
		6.0	3.0	5.5	3.1	TB07631W
		6.0	4.0	5.5	3.1	TB07641W
		8.0	1.0	5.5	2.9	TB07811W
		8.0	2.0	5.5	2.9	TB07821W
		8.0	3.0	5.5	2.9	TB07831W
		8.0	4.0	5.5	2.9	TB07841W
	 <p>Ti Base UniFit Abutment, Non-Engaged</p>	4.0	1.0	4.5	3.2	TB07412
		4.0	2.0	4.5	3.2	TB07422
		4.0	3.0	4.5	3.2	TB07432
		4.0	4.0	4.5	3.2	TB07442
		6.0	1.0	4.5	3.1	TB07612
		6.0	2.0	4.5	3.1	TB07622
		6.0	3.0	4.5	3.1	TB07632
		6.0	4.0	4.5	3.1	TB07642
		8.0	1.0	4.5	2.9	TB07812
		8.0	2.0	4.5	2.9	TB07822
		8.0	3.0	4.5	2.9	TB07832
		8.0	4.0	4.5	2.9	TB07842

	Description	RH	GH	D1	D2	Catalog No.
	<p>Ti Base UniFit Abutment, Non-Engaged Wide</p>	4.0	1.0	5.5	3.2	TB07412W
		4.0	2.0	5.5	3.2	TB07422W
		4.0	3.0	5.5	3.2	TB07432W
		4.0	4.0	5.5	3.2	TB07442W
		6.0	1.0	5.5	3.1	TB07612W
		6.0	2.0	5.5	3.1	TB07622W
		6.0	3.0	5.5	3.1	TB07632W
		6.0	4.0	5.5	3.1	TB07642W
		8.0	1.0	5.5	2.9	TB07812W
		8.0	2.0	5.5	2.9	TB07822W
		8.0	3.0	5.5	2.9	TB07832W
		8.0	4.0	5.5	2.9	TB07842W

C-Type Ti Base Abutments | Recommended Torque 35(Ncm)

For further product information and use please refer to IFU028

	Description	RH	GH	D1	D2	Catalog No.
	<p>C-Type Ti Base UniFit Abutment, Engaged</p>	4.7	1.0	4.3	2.9	TB07414
		4.7	2.0	4.3	2.9	TB07424
		4.7	3.0	4.3	2.9	TB07434
		4.7	4.0	4.3	2.9	TB07444
	<p>C-Type Ti Base UniFit Abutment, Engaged Wide</p>	4.7	1.0	6.0	2.9	TB07414W
		4.7	2.0	6.0	2.9	TB07424W
		4.7	3.0	6.0	2.9	TB07434W
		4.7	4.0	6.0	2.9	TB07444W
	<p>C-Type Ti Base UniFit Abutment, Non-Engaged</p>	4.7	1.0	4.3	2.9	TB07415
		4.7	2.0	4.3	2.9	TB07425
		4.7	3.0	4.3	2.9	TB07435
		4.7	4.0	4.3	2.9	TB07445
	<p>C-Type Ti Base UniFit Abutment, Non-Engaged Wide</p>	4.7	1.0	6.0	2.9	TB07415W
		4.7	2.0	6.0	2.9	TB07425W
		4.7	3.0	6.0	2.9	TB07435W
		4.7	4.0	6.0	2.9	TB07445W



CAD CAM | Angulated Screw Channel



The angulated screw channel (ASC) solution offers a transformative approach to dental restorations. ASC strategically places a screw access hole at an angle within the prosthesis, optimizing both function and esthetics.

By integrating digital planning and specialized drivers, ASC enhances accuracy and predictability in implant-supported restorations. This approach signifies a significant advancement in dental care, prioritizing esthetics and functionality to ensure patient satisfaction.

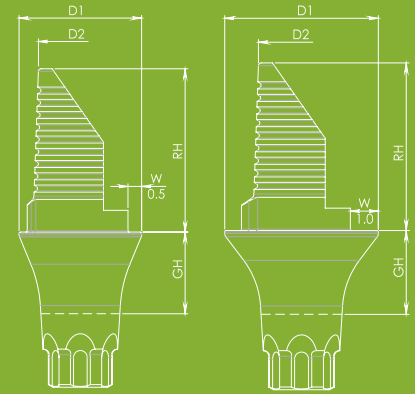
Adin's angulated screw channel Ti bases support gingival heights of 1-3mm for every each implant platform and allow for angulation of up to 20 degrees.



Ti Base Abutment Angular

	RH	GH	D1	D2	Catalog No.		RH	GH	D1	D2	Catalog No.
 <p>Ti Base Abutment Angular Engaged</p>	4.0	1.0	4.5	3.2	TB07413	 <p>Ti Base Abutment Angular Engaged Wide</p>	4.0	1.0	5.5	3.2	TB07413W
	4.0	2.0	4.5	3.2	TB07423		4.0	2.0	5.5	3.2	TB07423W
	4.0	3.0	4.5	3.2	TB07433		4.0	3.0	5.5	3.2	TB07433W
	6.0	1.0	4.5	3.1	TB07613		6.0	1.0	5.5	3.1	TB07613W
	6.0	2.0	4.5	3.1	TB07623		6.0	2.0	5.5	3.1	TB07623W
	6.0	3.0	4.5	3.1	TB07633		6.0	3.0	5.5	3.1	TB07633W
	8.0	1.0	4.5	2.9	TB07813		8.0	1.0	5.5	2.9	TB07813W
	8.0	2.0	4.5	2.9	TB07823		8.0	2.0	5.5	2.9	TB07823W
	8.0	3.0	4.5	2.9	TB07833	8.0	3.0	5.5	2.9	TB07833W	
	Abutments are supplied with UF0001 screw. Recommended torque 30-35Ncm. Also available separately.										UF0001

Angulated Tools

	Description	L	L2	D1	D2	Catalog No.
	Angulated Screw Extractor Hand Driver	24.7	10	1.4	9.4	RP6400
	Angulated Star Screw Hand Driver - Short 23.4L	23.4	9.0	1.4	9.4	RP6401
	Angulated Star Screw Hand Driver - Long 28.4L	28.4	14.0	1.4	9.4	RP6402
	Angulated Star Screw Torque Driver - Short 17.0L	17.0	11.0	1.4	7.0	RP6403
	Angulated Star Screw Torque Driver - Long 22.0L	22.0	16.0	1.4	7.0	RP6404
	Angulated Star Screw Handpiece Driver - Extra Short 20.0L	20.0	7.0	1.4	2.35	RP6405
	Angulated Star Screw Handpiece Driver - Short 25.0L	25.0	12.0	1.4	2.35	RP6406
	Angulated Star Screw Handpiece Driver - Long 30.0L	30.0	17.0	1.4	2.35	RP6407



Digital Analogs

	Description	L	D1	Catalog No.		Description	Catalog No.		Description	L	D1	Catalog No.
	UniFit Digital Model Analog	10.0	3.55	UF1000		Retaining Screw	RS1002		UniFit Implant Analog	12.6	3.6	UF0007

Screws

	Description	Catalog No.
	UniFit Abutment Screw M1.6	UF0001





TMA - Multi Unit Screws

	Description	Catalog No.
	TMA Scan Body Screw	TM0001
	TMA Prosthetic Screw	RS3404

STMA / TMA Scan Bodies | For Intra-oral and Desktop Scanner

	Description	L	D1	Catalog No.		Description	L	D1	Catalog No.
	Single TMA Scan Body	6.0	4.9	TM0006S		TMA Scan Body	6.0	4.9	TM0006
		9.0	4.9	TM0009S			9.0	4.9	TM0009

STMA / TMA Cementing Cone & Temporary Cylinder

	Description	L	D1	D2	H	Catalog No.		Description	L	D1	D2	Catalog No.
	Single TMA Titanium Temporary	12.0	4.9	3.5	10.5	RS4900S		Single TMA Cementing Cone, low profile	4.9	5.5	3.2	TM0011S
	TMA Titanium Temporary	12.0	4.9	3.5	10.5	RS4900		TMA Cementing Cone, low profile	4.9	5.5	3.2	TM0011
								TMA Cementing Cone	4.9	4.9	3.8	TM0010

Tool Drivers

	Description	L	Catalog No.		Description	L	Catalog No.
	Star Hand Driver Short	23.4	RP0064		Star Hand Driver Long	28.4	RP0004

TMA™ - Multi Unit Recommended Torque 35(Ncm)

Our TMA™ (Trans Mucosal Abutment) system is indicated for multiple-unit, screw-retained restorations, and may be used in combination with an implant-level framework design.

- Elevates restorative seating platform when implant-level restoration is not practical
- Provides better access when using implants with divergent angles
- Accommodates full and partial edentulous arches
- Available in straight or angled (17°, 30°, 45°) with different gingival heights
- Abutments are delivered with handles for easy insertion and seating



		Description	GH	Catalog No.
		UniFit Straight Trans Mucosal Abutment 1mm	1.0	UF0032
		UniFit Straight Trans Mucosal Abutment 2mm	2.0	UF0033
		UniFit Straight Trans Mucosal Abutment 3mm	3.0	UF0034
		UniFit Straight Trans Mucosal Abutment 4mm	4.0	UF3729
		UniFit Straight Trans Mucosal Abutment 5mm	5.0	UF3730
		UniFit Angled Trans Mucosal Abutment 17° 1.5mm	1.5	UF3732
		UniFit Angled Trans Mucosal Abutment 17° 2.5mm	2.5	UF3734
		UniFit Angled Trans Mucosal Abutment 17° 3.5mm	3.5	UF3737
		UniFit Angled Trans Mucosal Abutment 17° 4.5mm	4.5	UF3739
		UniFit Angled Trans Mucosal Abutment 30° 1mm	1.0	UF3726
		UniFit Angled Trans Mucosal Abutment 30° 2mm	2.0	UF3727
		UniFit Angled Trans Mucosal Abutment 30° 3mm	3.0	UF3735
		UniFit Angled Trans Mucosal Abutment 30° 4mm	4.0	UF3738

Transfers

	Description	L	D1	D2	Catalog No.
	TMA Impression Coping Open Tray	11.0	4.9	3.1	RS5006
	TMA Closed Tray Transfer	8.0	4.9	4.1	RS5011
	TMA Healing Cup	5.5	4.9	3.5	RS5005

Analogs

	Description	L	D1	D2	Catalog No.
	TMA Abutment Replica	16.8	3.35	-	RS5004
	TMA Digital Model Replica <small>Recommended torque 15(Ncm)</small>	12.0	4.9	3.8	RS1001
	Description	L	D1	Catalog No.	
	TMA Scan Body	6.0	4.9	TM0006	
		9.0	4.9	TM0009	

TMA Screw For Scan Body & Cementing Cone

	Description	Catalog No.
	TMA Scan Body Screw	TM0001

TMA Screw Temporary Cylinder & STMA Direct Option

	Description	Catalog No.
	TMA Prosthetic Screw	RS3404

Snap-On

	Description	L	D1	D2	Catalog No.		Description	Catalog No.
	TMA Snap-On Transfer	8.0	4.9	3.2	RS5012		IRIS™, Impression coping	IR0179

TMA Prosthetics

	Description	L	D1	D2	H	Catalog No.		Description	L	D1	D2	Catalog No.
	TMA Titanium Temporary	12.0	4.9	3.5	10.5	RS4900		TMA Cementing Cone, low profile	4.9	5.5	3.2	TM0011
	TMA Plastic Casting Sleeve /Prosthetic Screw	12.0	4.9	3.3	10.5	RS5001		TMA Cementing Cone	4.9	5.5	2.9	TM0010

Tool Drivers | For Angled TMA/TMA Prosthetic Screws

For Angled TMA/TMA prosthetic screw

	Description	L	Catalog No.
	Star Hand Driver Short	23.4	RP0064
	Star Hand Driver Long	28.4	RP0004
	Star Torque Driver-Short	20.4	RP0065
	Star Torque Driver-Long	25.4	RP0005

For straight TMA

	Description	L	Catalog No.
	TMA Hex Torque Driver - Short	20	RS6197
	TMA Hex Torque Driver - Long	25	RS6196
	TMA Female Hand Hex Driver-Short	22.4	RS6193
	TMA Female Hand Hex Driver-Long	28.4	RS6191
	TMA Hex Handpiece Adapter-Short	20	RS6194
	TMA Hex Handpiece Adapter-Long	25	RS6195A

Overdenture Restoration

Recommended Torque 35(Ncm)



		Description	GH	RH	H	Catalog No.
		UniFit Ball Attachment 0.5mm	0.6	2.7	4.1	UF0051
		UniFit Ball Attachment 1mm	1.0	2.7	4.5	UF0052
		UniFit Ball Attachment 2mm	2.0	2.7	5.5	UF0053
		UniFit Ball Attachment 3mm	3.0	2.7	6.5	UF0054
		UniFit Ball Attachment 4mm	4.0	2.7	7.5	UF0055
		UniFit Ball Attachment 5mm	5.0	2.7	8.5	UF0056

	Description	L	Ø	Catalog No.
	Ball Attachment Replica	16.6	4.0	RS5740

	Description	L	Ø	D2	Catalog No.
	Plastic Ball Cap White (Nylon)	2.6	4.1	3.6	RS2660
	Plastic Ball Cap Pink Soft (Nylon)	2.6	4.1	3.6	RS2662
	Titanium Ball Cap	2.9	4.7	4.7	RS2670

	Description	Catalog No.
	Torque Driver for Ball Attachment	RS6090

Grip™ - Overdenture Attachment

As an addition to our wide variety of prosthetic solutions.

Implant supported overdentures are among the most practical prosthetic solutions for patients who cannot utilize fixed restorations, or as an interim solution for patients who are waiting for the osteointegration process of their newly placed implants.

The Grip™ attachment system is a versatile solution, designed to ensure maximum denture retention and stability both for maxillary and mandibular dentures. The variety of retentive caps allow dentists to choose the required retention level needed for each individual case and can easily be replaced, when needed.

The Grip™ attachment system is available for Internal Hex in a range of gingival heights, to enable a reliable, long lasting and cost-effective solution for your patients.

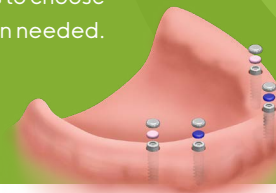
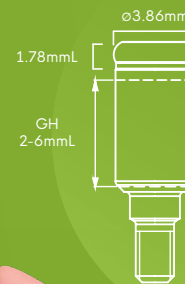



Grip™ Abutments

	Description	Catalog No.
	Grip UF Abutment 1mm	UF0101
	Grip UF Abutment 2mm	UF0102
	Grip UF Abutment 3mm	UF0103
	Grip UF Abutment 4mm	UF0104
	Grip UF Abutment 5mm	UF0105
	Grip UF Abutment 6mm	UF0106

	Description	Catalog No.
	Grip™ for TMA	TM0100
	Grip™ for Bar, M2 thread	RS0101

Included in Sales Pack







Grip™ Processing Set

	Description		Description	Catalog No.
	Housing		Light	RS6426
	Processing		Regular	
	Extra Light		Block Out Spacer	



Or





Grip™ Extended Range processing set

	Description		Description	Catalog No.
	Housing		Light	RS6427
	Processing		Regular	
	Zero		Block Out Spacer	
	Extra Light			

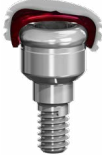
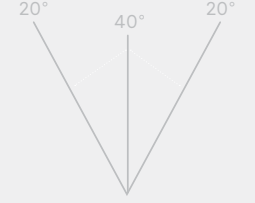

Grip™ Retention Caps

Grip Retention 4 Pack		Description	Catalog No.
		 Extra Light	RS6417
		 Light	RS6418
		 Regular	RS6419

Grip™ Extended Range Retention 4 Pack		Description	Catalog No.
		 Zero	RS6420
		 Extra Light	RS6421
		 Light	RS6422
		 Regular	RS6423

Grip™ Accessories

	Description	Catalog No.		Description	Catalog No.	
	Grip™ Impression Coping 4 Pack Includes RS6415 Grip™ Processing 4 Pack	RS6414		Grip™ Replica 4 Pack	RS2508	
	Metal Housing 4 Pack Includes RS6415 Grip™ Processing 4 Pack	RS6413			Grip™ Processing 4 Pack	RS6415
	Grip™ Block Out Spacer 4 Pack	RS6424			Grip™ Processing 20 Pack	RS6416

Grip™ Tools

	Description	Catalog No.
	Grip™ core tool	RS6200

Designed for inserting and removing the Grip™ retention males from the metal housing

	Description	Catalog No.		Description	Catalog No.		Description	Catalog No.
	Star Hand Driver Short	RP0064		1.27 Hex torque driver-long	RS6082		1.27 Hex driver for handpiece - long	RS9035
	Star Hand Driver Long	RP0004		1.27 Hex torque driver-short	RS6080		1.27 Hex driver for handpiece - short	RS9030

Surgical Kits

Successful surgical procedures start with having the right instruments and tools to ensure your desired treatment outcomes are met.

That's why our range has everything you need, including drills, keys, ratchets and insertion tools.









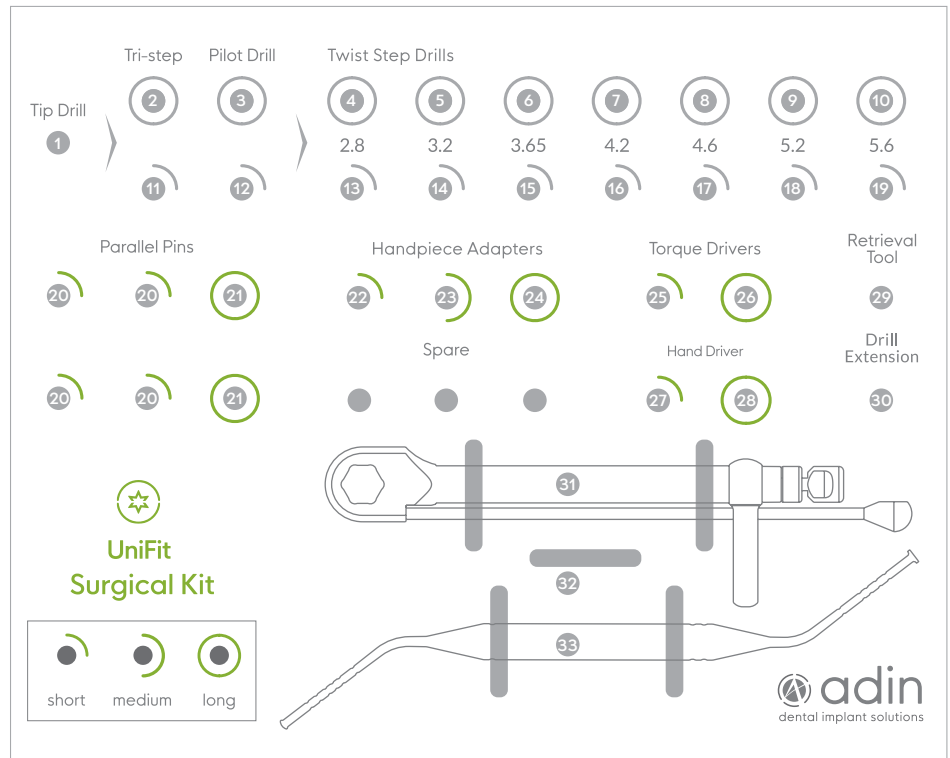









Not only do they make procedures safer and simpler, they result in an enhanced patient experience as well.



Our Surgical Kits streamline and simplify your implant procedures.









Premium Kit UF6301





	Drills	Catalog No.
1	 Tip Drill	RS8032
2	 Tri-Step Drill - Long	TD2218
3	 Pilot Drill 2mmD x 8-18mmL	DL1820
4	 Twist Step Drill 2.3/2.8mmD x 8-18mmL	DL1828
5	 Twist Step Drill 2.8/3.2mmD x 8-18mmL	DL1832
6	 Twist Step Drill 3.2/3.6mmD x 8-18mmL	DL1836
7	 Twist Step Drill 3.8/4.2mmD x 8-18mmL	DL1842
8	 Twist Step Drill 4.2/4.6mmD x 8-18mmL	DL1846
9	 Twist Step Drill 4.8/5.2mmD x 8-18mmL	DL1852
10	 Twist Step Drill 5.2/5.6mmD x 8-18mmL	DL1856
11	 Tri-Step Drill - Short	TD1511
12	 Pilot Drill 2mmD x 6-13mmL	DL1320
13	 Twist Step Drill 2.3/2.8mmDx6-13mmL	DL1328
14	 Twist Step Drill 2.8/3.2mmDx6-13mmL	DL1332
15	 Twist Step Drill 3.2/3.6mmDx6-13mmL	DL1336
16	 Twist Step Drill 3.8/4.2mmDx6-13mmL	DL1342
17	 Twist Step Drill 4.2/4.6mmDx6-13mmL	DL1346
18	 Twist Step Drill 4.8/5.2mmDx6-13mmL	DL1352
19	 Twist Step Drill 5.2/5.6mmDx6-13mmL	DL1356

	Parallel Pins	Catalog No.
20	 Parallel Pin Short 11mm (qty. 4)	RS6150
21	 Parallel Pin Short 16mm (qty. 2)	RS6155

	Insertion Tools	Catalog No.
22	 UniFit Star Handpiece Adapter - Short	UF0068
23	 UniFit Star Handpiece Adapter - Medium	UF0071
24	 UniFit Star Handpiece Adapter - Long	UF0074

	Drivers	Catalog No.
25	 UniFit Star Torque Driver - Short	UF0067
26	 UniFit Star Torque Driver - Long	UF0066
27	 Star Hand Driver - Short	RP0064
28	 Star Hand Driver - Long	RP0004









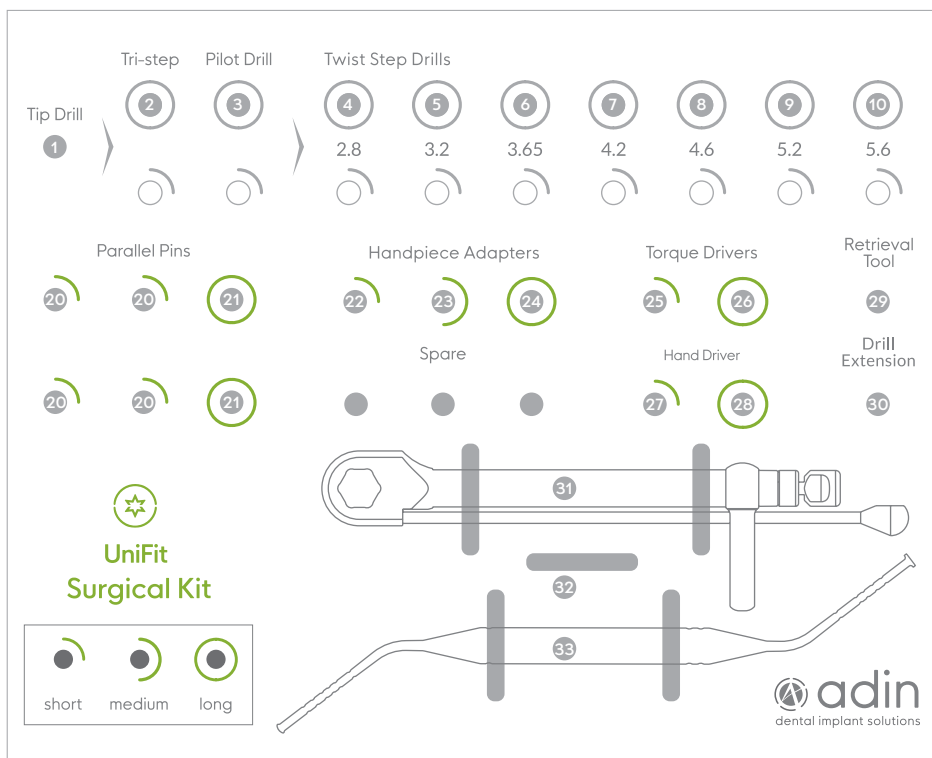

	Drill Extension	Catalog No.
29	 UniFit Ratchet Retrieval tool for abutments	UF3401
30	 Drill Extension	RS9027

	Surgical Tools	Catalog No.
31	 Surgical Torque Ratchet 35-100 Ncm	RS6111
32	 Wrench Ratchet Surgical Instruments Handle	RA0050
33	 Depth Probe	RS6180



*Products may be ordered separately as an addition to the kit





Advanced Kit UF6322







	Drills	Catalog No.
1	 Tip Drill	RS8032
2	 Tri-Step Drill - Long	TD2218
3	 Pilot Drill 2mmD x 8-18mmL	DL1820
4	 Twist Step Drill 2.3/2.8mmD x 8-18mmL	DL1828
5	 Twist Step Drill 2.8/3.2mmD x 8-18mmL	DL1832
6	 Twist Step Drill 3.2/3.6mmD x 8-18mmL	DL1836
7	 Twist Step Drill 3.8/4.2mmD x 8-18mmL	DL1842
8	 Twist Step Drill 4.2/4.6mmD x 8-18mmL	DL1846
9	 Twist Step Drill 4.8/5.2mmD x 8-18mmL	DL1852
10	 Twist Step Drill 5.2/5.6mmD x 8-18mmL	DL1856

	Parallel Pins	Catalog No.
20	 Parallel Pin Short 11mm (qty. 4)	RS6150
21	 Parallel Pin Short 16mm (qty. 2)	RS6155

	Insertion Tools	Catalog No.
22	 UniFit Star Handpiece Adapter - Short	UF0068
23	 UniFit Star Handpiece Adapter - Medium	UF0071
24	 UniFit Star Handpiece Adapter - Long	UF0074

	Drivers	Catalog No.
25	 UniFit Star Torque Driver - Short	UF0067
26	 UniFit Star Torque Driver - Long	UF0066
27	 Star Hand Driver - Short	RP0064
28	 Star Hand Driver - Long	RP0004

	Drill Extension	Catalog No.
29	 UniFit Ratchet Retrieval tool for abutments	UF3401
30	 Drill Extension	RS9027

	Surgical Tools	Catalog No.
31	 Surgical Torque Ratchet 35-100 Ncm	RS6111
32	 Wrench Ratchet Surgical Instruments Handle	RA0050
33	 Depth Probe	RS6180

*Products may be ordered separately as an addition to the kit

Drills and Tools

Our DLC (Diamond-like Carbon) Tri-Step/Twist Step Surgical Drills are designed for a simpler, faster, and safer surgical drilling experience.

Here are the benefits:

Simplify the cutting process, save time, and minimize risks with our Tri-Step & Twist-Step DLC drills.

Improved DLC drill coating provides state-of-the-art hardness and slickness, increasing the lifespan of the drill, maintaining sharpness for extended drilling, and generating less heat. This reduces the chances of heating the bone or complications arising from conventional drilling protocols.

Available in diameters ranging from 2.0 mm to 5.6 mm.

Specially designed for Adin's implants and suitable for Adin's simple and convenient drilling protocol.

Clearly and conveniently marked and can be used with or without drill stops.



Tri-Step drills

Adin's Tri-Step Drills condense drilling protocols and avoid the need for multiple drills throughout complex procedures.









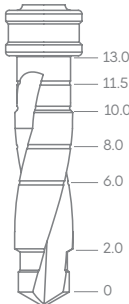

Since friction at the cutting site is reduced, complications common with high-speed drilling are decreased and faster & better recovery can occur.

The drills are designed to reduce friction at the cutting site, therefore leading to a decrease in complications that are often associated with high-speed drilling. This can result in a faster and more efficient recovery for patients.









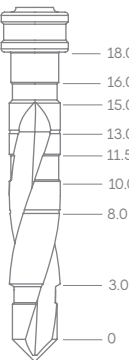

L		Ø	Size	Catalog No.
		1.8-3.2	Short	TD1511
		1.8-3.2	Long	TD2218

Twist Step drills

Short 6-13mm



L		Ø	Color	Catalog No.
		2.0	White	DL1320
		1.8-2.5	Purple	DL1325
		2.3-2.8	Red	DL1328
		2.8-3.2	Blue	DL1332
		3.2-3.6	Green	DL1336
		3.9	Pink	DL1339
		3.8-4.2	Black	DL1342
		4.2-4.6	Yellow	DL1346
		4.8-5.2	Brown	DL1352
		5.2-5.6	Grey	DL1356

Long 8-18mm

L		Ø	Color	Catalog No.
		2.0	White	DL1820
		1.8-2.5	Purple	DL1825
		2.3-2.8	Red	DL1828
		2.8-3.2	Blue	DL1832
		3.2-3.6	Green	DL1836
		3.9	Pink	DL1839
		3.8-4.2	Black	DL1842
		4.2-4.6	Yellow	DL1846
		4.8-5.2	Brown	DL1852
		5.2-5.6	Grey	DL1856

Surgical Tools



	Description	Catalog No.
	Surgical Torque Ratchet 35-100 Ncm	RS6111
	Wrench Ratchet	RS6100
	Surgical Driver	RS7001
	Depth Probe	RS6180

Tools







	Description	Catalog No.
	Wrench Ratchet Surgical Instruments Handle 17mm	RA0050
	Drill Extension	RS9027
	Parallel Pin 11mm	RS6150
	Parallel Pin 16mm	RS6155
	UniFit Star Handpiece Adapter - Short	UF0068
	UniFit Star Handpiece Adapter - Medium	UF0071
	UniFit Star Handpiece Adapter - Long	UF0074
	UniFit Star Torque Driver Short	UF0067
	UniFit Star Torque Driver Long	UF0066

Prosthetic Tools







Ratchet



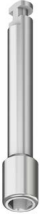

	Description	Catalog No.
	Prosthetic Torque Ratchet 15-35 Ncm	RS6112

	Description	Catalog No.
	1.27 Hex Torque Driver 20.4mm	RS6080
	1.27 Hex Torque Driver 25.4mm	RS6082
	TMA/FC Hex Torque Driver 25mm *For straight TMA/Flat connection	RS6196
	TMA/FC Hex Torque Driver 20mm *For straight TMA/Flat connection	RS6197
	Star Torque Driver 20.4mm *For Angled TMA/TMA prosthetic screw	RP0065
	Star Torque Driver 25.4mm *For Angled TMA/TMA prosthetic screw	RP0005
	Torque Driver for Ball Attachment 14.4mm	RS6090

Handpiece

	Description	Catalog No.
	Star Handpiece Driver - Short *For angled TMA/TMA prosthetic screws	RP0018
	Star Handpiece Driver - Long *For angled TMA/TMA prosthetic screws	RP0019
	TMA/FC Hex Handpiece Adapter 25mm *For straight TMA/Flat connection	RS6195A
	TMA/FC Hex Handpiece Adapter 20mm *For straight TMA/Flat connection	RS6194

Hand Drivers

	Description	Catalog No.
	TMA/FC Female Hand Hex Driver 28.4mm *For straight TMA/Flat connection	RS6191
	TMA/FC Female Hand Hex Driver 22.4mm *For straight TMA/Flat connection	RS6193
	Star Hand Driver 23.4mm *For Angled TMA/TMA prosthetic screw	RP0064
	Star Hand Driver 28.4mm *For Angled TMA/TMA prosthetic screw	RP0004

Retrieval Screw

	Description	Catalog No.
	UniFit Ratchet Retrieval Tool for Abutments	UF3401

Guided Surgery

Introducing the adinguide™: a guided surgery tool designed to enhance your clinic.

Our kits are tailored to support effortless and precise implant placement. With our proprietary ActiveFlow™ Irrigation technology, where coolant is efficiently delivered to the bone, preventing overheating.

The adinguide™ drills feature carved channels for direct coolant flow from your hand-piece to the osteotomy site. Our intuitive drill kit accommodates different implant sizes and lengths, while the tissue punch and pilot drill allow flapless access.

The keyless procedure offers easy handling and clear visibility of the surgical site.

Our self-centering drills utilize a diameter cylinder at the top to ensure accurate positioning within the guide's sleeve. Additionally, built-in stoppers guarantee precise and consistent drilling depths.



Guided Surgery Kit Implants Drills GSK001

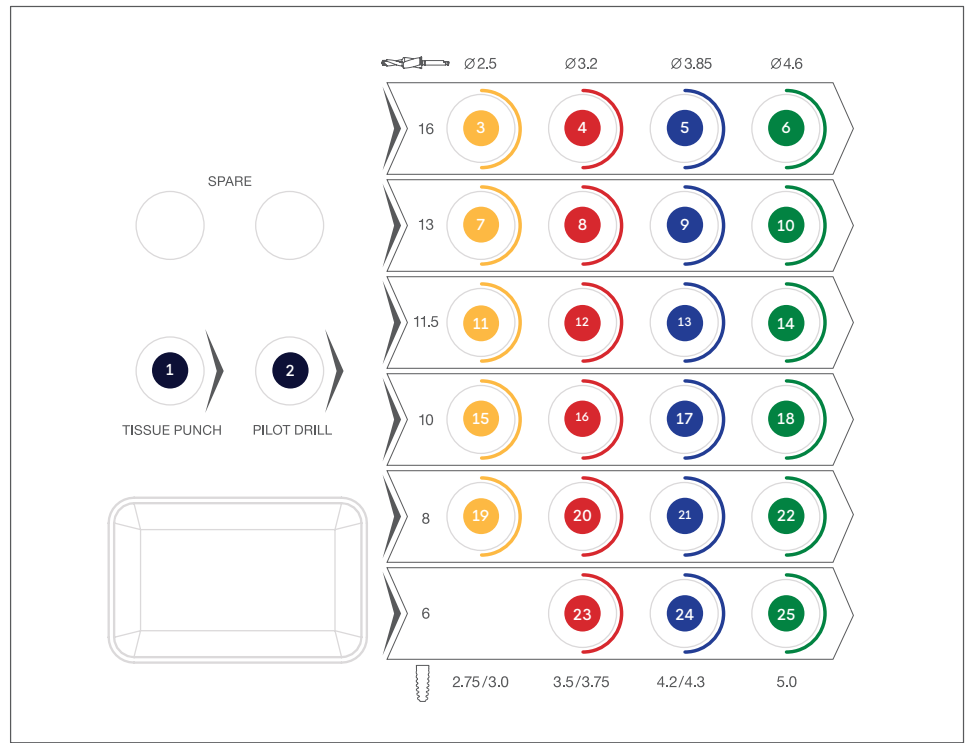

	Drills	Catalog No.		Drills	Catalog No.
1		GS5055	5		GS0638
2		GS0625	9		GS0838
3		GS0825	13		GS1038
7		GS1025	17		GS1138
11		GS1125	21		GS1338
15		GS1325	24		GS1638
19		GS1625	6		GS0646
4		GS0632	10		GS0846
8		GS0832	14		GS1046
12		GS1032	18		GS1146
16		GS1132	22		GS1346
20		GS1332	25		GS1646
23		GS1632			



For full
guided
procedure:



Unified Conical
Implant Platform



GS Tools Kit UniFit
GSK005



5.5mmD Sleeve
GS0055

Guided Surgery Kit UniFit™ Implants Tools GSK005

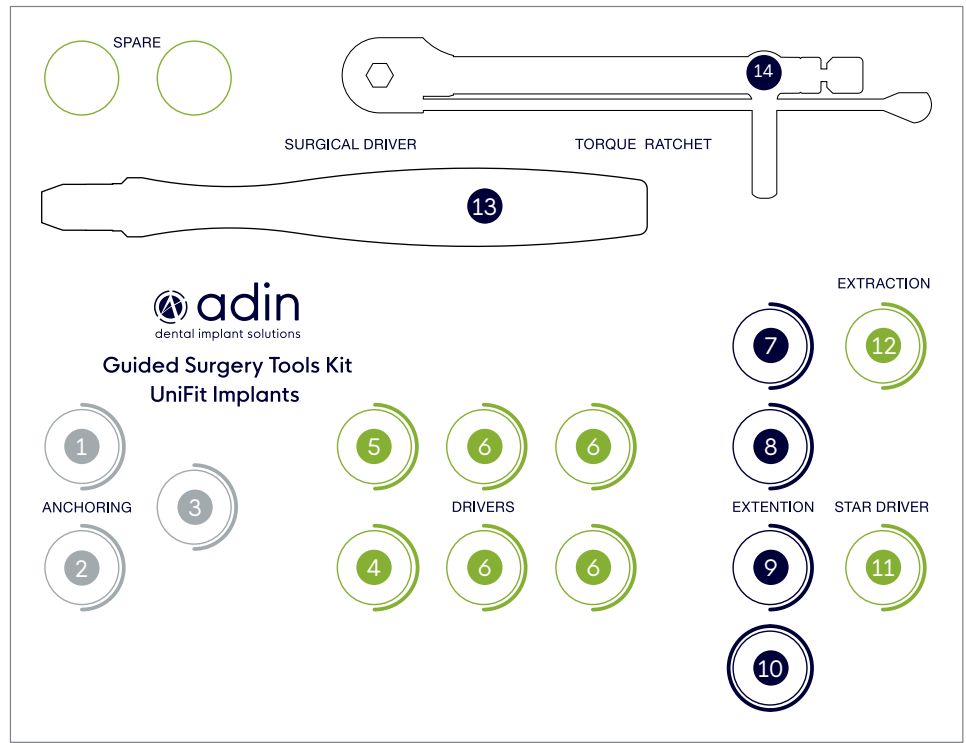

	Description	Catalog No.
1	 Anchoring Drill S-2.0, 2.0/1.5mmDx19mmL	GS1915
2	 Anchoring Drill S-2.0, 2.0/1.7mmDx19mmL	GS1917
3	 Handpiece Guide Fixation Screw Driver	GS0028
4	 Guided UniFit Handpiece Fixture Mount S-5.5	GS5041
5	 Guided UniFit Ratchet Fixture Mount S-5.5	GS5043
6	 Guided UniFit Ratchet Fixture Mount S-5.5, Screw Retained (qty.4)	GS5037
7	 Manual Socket L10.5	GS0023
8	 Manual Socket L14.5	GS0024
9	 Handpiece Socket L10.5	GS0021
10	 Handpiece Socket L14.5	GS0022
11	 Star Hand Driver - Long	RP0004
12	 UniFit Ratchet Retrieval Tool	GS5046
13	 Guide Fixation Screw Driver (Surgical Driver)	GS0027
14	 Surgical Torque Ratchet 35-100 Ncm for hex 4mm	GS6111



For full
guided
procedure:



Unified Conical
Implant Platform





GS Tools Kit RS
GSK001







5.5mmD Sleeve
GS0055



18mm Drills

	Description	Catalog No.
	Drill S-5.5, 2.5/1.8mmDx18.0mmL	GS1825
	Drill S-5.5, 3.2/2.5mmDx18.0mmL	GS1832
	Drill S-5.5, 3.85/3.2mmDx18.0mmL	GS1838
	Drill S-5.5, 4.6/3.85mmDx18.0mmL	GS1846
	Drill S-3.3, 2.5/1.8mmDx18.0mmL	GSN1825

Accessories

	Description	Purchase Options	Catalog No.
	Guided Vertical Fixation Screw S-5.5	x3 pack	GS0007
	2.0mmD Anchoring Screw	x3 pack	GS1920
	2.0mmD Anchoring Sleeve	x3 pack	GS0020
	5.5mmD Sleeve	x1 pack	GS0055
		x3 pack	GS0055x3
		x10 pack	GS0055x10

* Illustrations are not to scale

* Availability of the products in some places is limited and depends on local regulations.

* For more information, please contact your local representative.



Industrial Park Allon Tavor, POB 1128, Afula 1811101, Israel
+972-4-6426732 | www.adin-implants.com